





Aqua thermal Super



Product lineup

Capacity(kW)	65/75	110/140
Appearance		
380-415V/3Ph/50Hz	●	●

Overview



Maximum water temperature up to 65°C



Minimum operation ambient temperature down to -25°C



DC Inverter technology allows precise consumption on real load



- High energy efficiency level A+++ for energy saving (65kW water outlet temperature at 35°C)
- High energy efficiency level A++ for energy saving (water outlet temperature at 55°C)



Multiple silence modes and operation protection are comfortable and secure to use



Refrigerant R32 75% less impact on global warming



- Group control for up to maximum 16 units with one controller.
- Maximum 16 controllers 256 units can be connected to BMS system.



Integrated inverter hydro module (Customized), simplify onsite installation

Wide application range

Ambient temperature

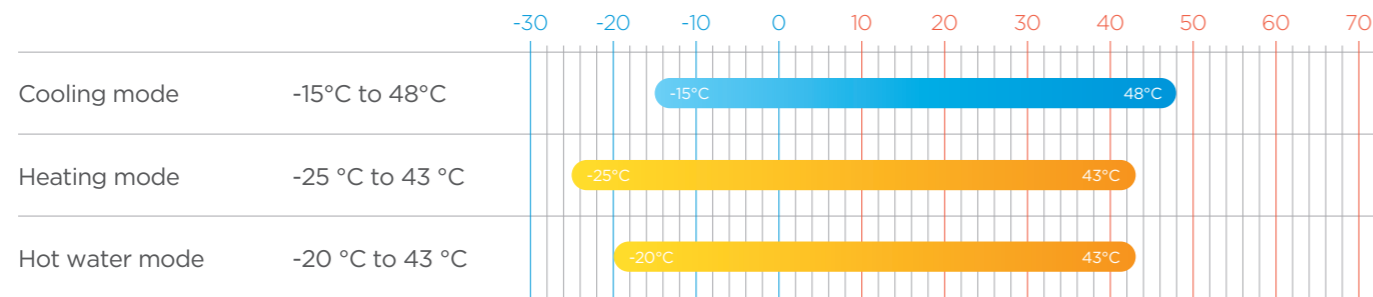

Outlet water temperature

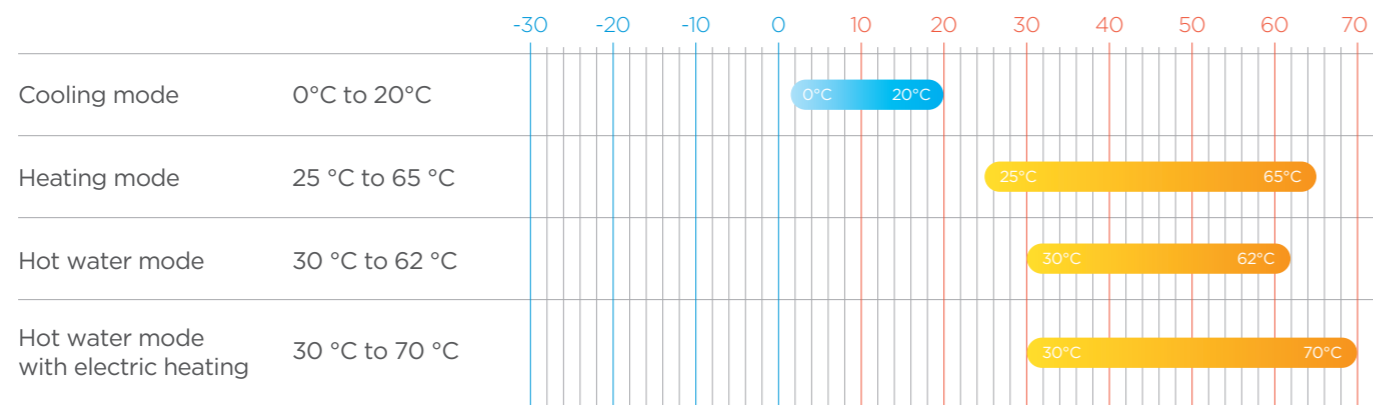

Notes:

1. Antifreeze fluid is needed when water outlet temperature less than 5°C.
2. Electric heater installed in the tank is field supplied.
3. The highest water temperature can reach 70°C, which can easily kill the bacteria in the tank.

terminals and scenarios

It can be matched with different kinds of terminals to meet the requirements of a variety of scenarios

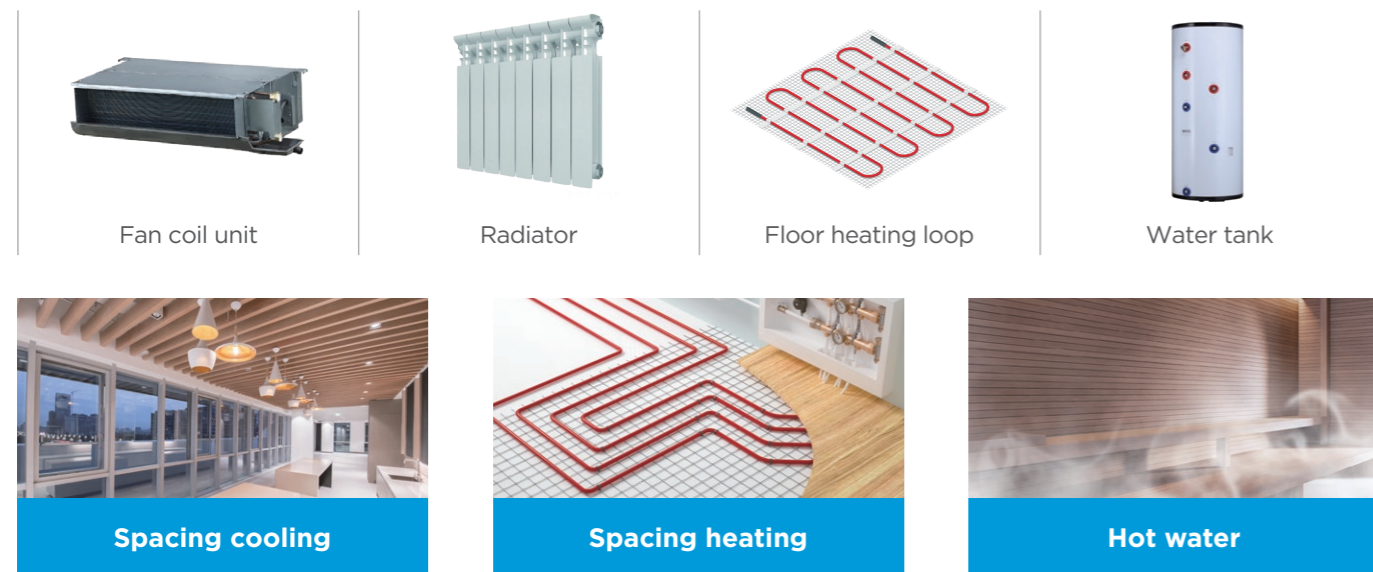

Modular design

Modularity is perfect when an extension of capacity becomes required as the building load range from 65kW to 1760kW



7 Levels of energy saving

For projects with temporary electricity supply restrictions, the outdoor unit supports 7 levels of energy management which can be set to output 40-100% capacity. It prevents tripping during electricity supply restriction conditions and remains system continue to operate.

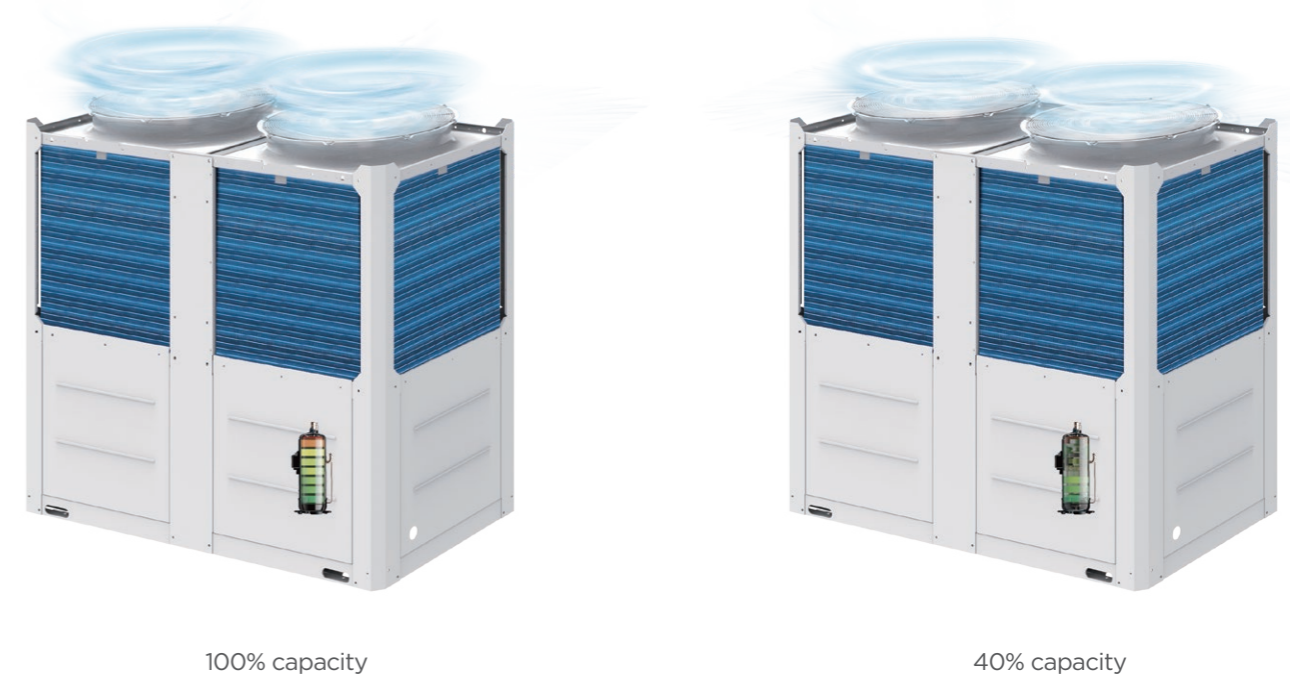

Advanced configuration

Full frequency conversion technology

DC variable frequency compressor + DC variable frequency fan + variable frequency water pump.

DC variable frequency compressor

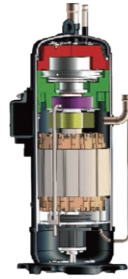

- More compact, weight reduced by 50%
- New structure enhances mid-frequency performance
- Specially designed scroll profile for R32
- Advanced permanent magnet DC motor improves low frequency band performance

DC variable frequency fan

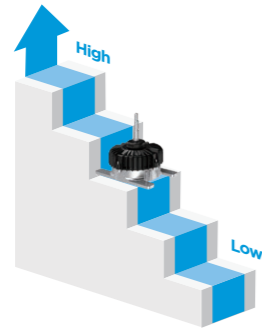

variable frequency water pump

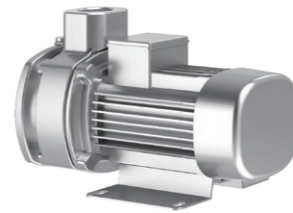

The compressor, fan and water pump can be stepless broadband regulation, and the refrigerant output can be accurately adjusted according to the indoor and outdoor load, so that the water outlet temperature and speed are constant. The unit does not need to start and stop frequently, more efficient and energy saving, and can bring comfortable and energy saving effect to the user.

Enhanced Vapor Injection (EVI) Compressor

Enhanced vapor injection and secondary supercooling technology is used to achieve ultra-low temperature -25°C operation, and make up for the lack of heat production at low temperature, improve energy efficiency;

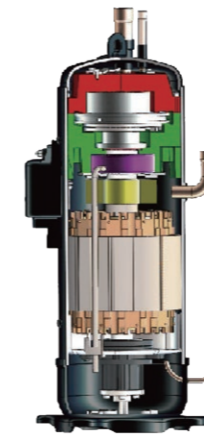

EVI compressor

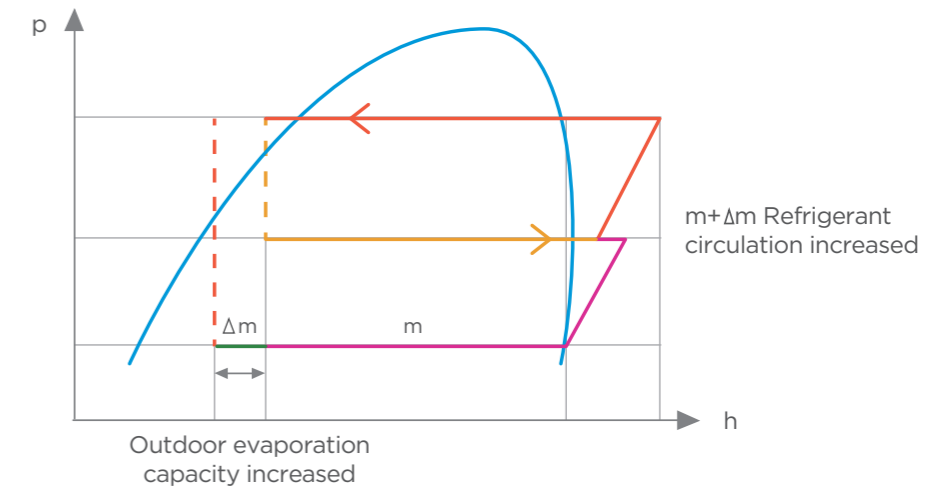

Precise Oil Control Technology

Four stages of oil control technology ensure all outdoor compressor oil is always kept at a safe level, eliminating any compressor oil shortage problems. Compressor internal oil separation. High-efficiency centrifugal oil separator (with separation efficiency of up to 99%) ensures that oil is separated from the discharge gas and returned to the compressors in a timely fashion. Oil balance pipe ensures oil distribution to keep compressor running normally. Auto oil return program monitors the running time and system status to ensure reliable oil return.

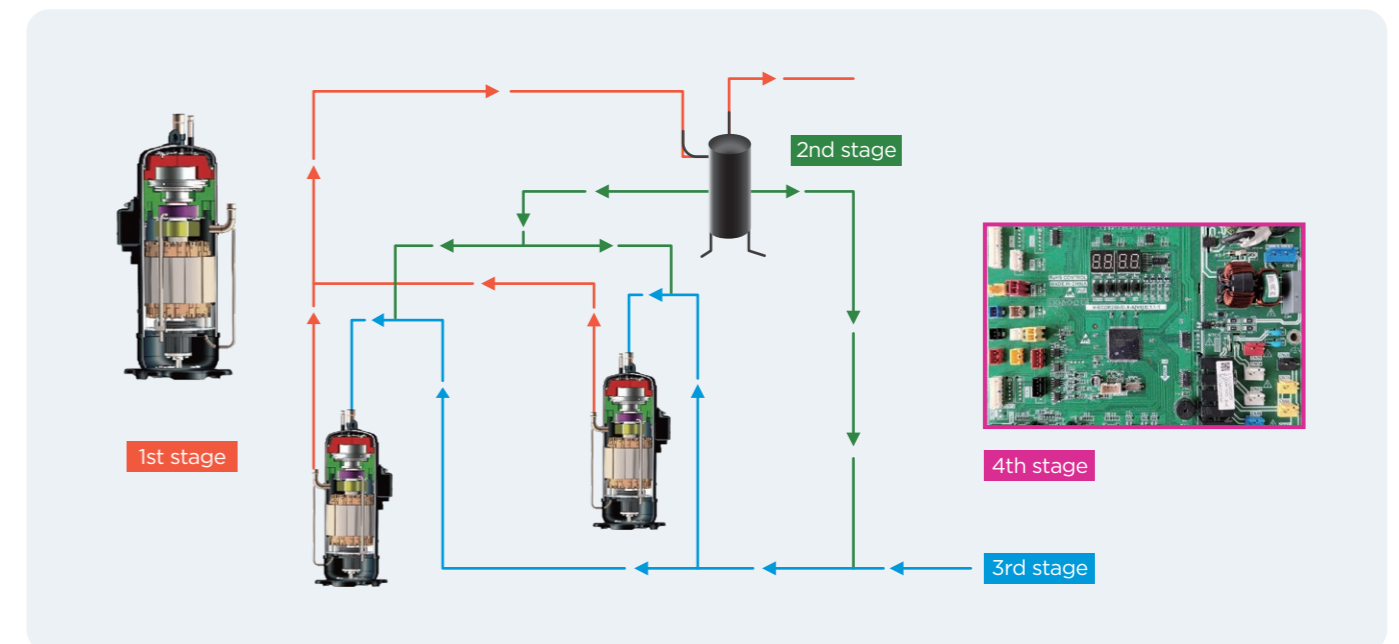
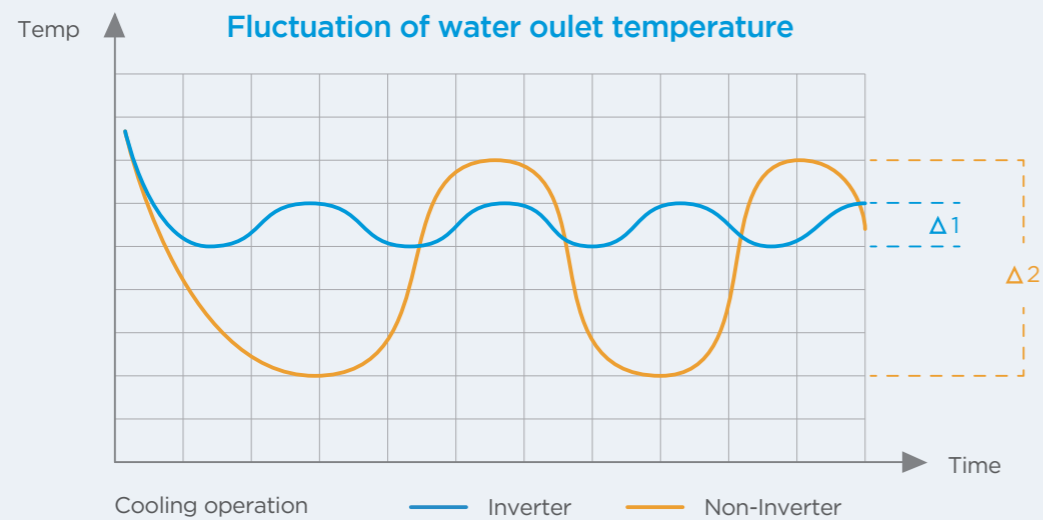

Micro channel refrigerant cooling technology

The refrigerant flows heat transfer directly inside the aluminum block, and the refrigerant flow channel is corrugated, which increases the heat transfer contact area between the refrigerant and the aluminum block, and the radiator thinner, improve the heat transfer efficiency of the refrigerant radiator, break through the higher water temperature limit.



Refrigerant Cooling PCB

Refrigerant cooling PCB technology reduces electric control heating under harsh working conditions, effectively reduce the temperature of electronic control components, ensure the stable and safe operation of the unit control system.

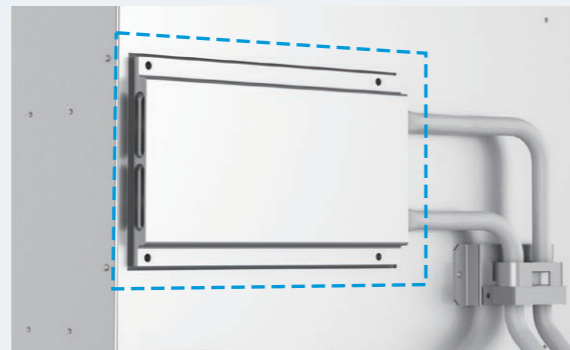

Precise flow control

Patented liquid distribution components maximize performance and minimize impact of defrosting operation. 500-step EXV with capillary tube allows stable and accurate gas flow control. Fast response results in higher efficiency and improved reliability.

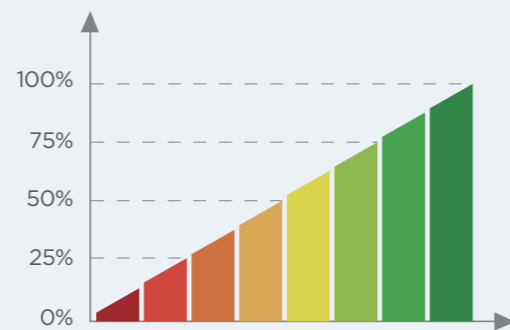

Multiple optimization design makes noise reduction

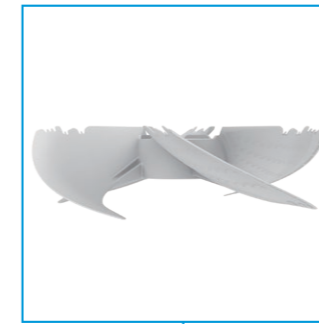

Optimized fan blade edge by CFD programs with analyzing air pressure distribution
Realize higher air volume, lower noise level.

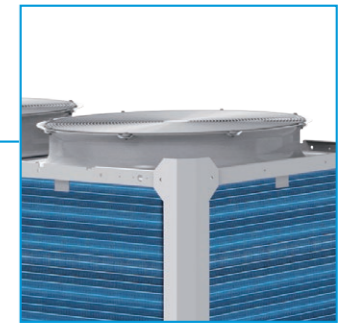

Guide air diffuser hood
Reduce noise effectively

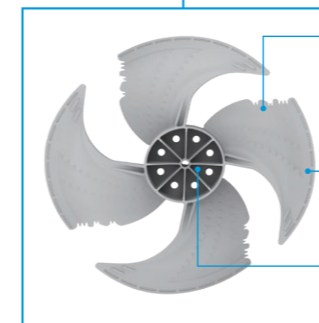
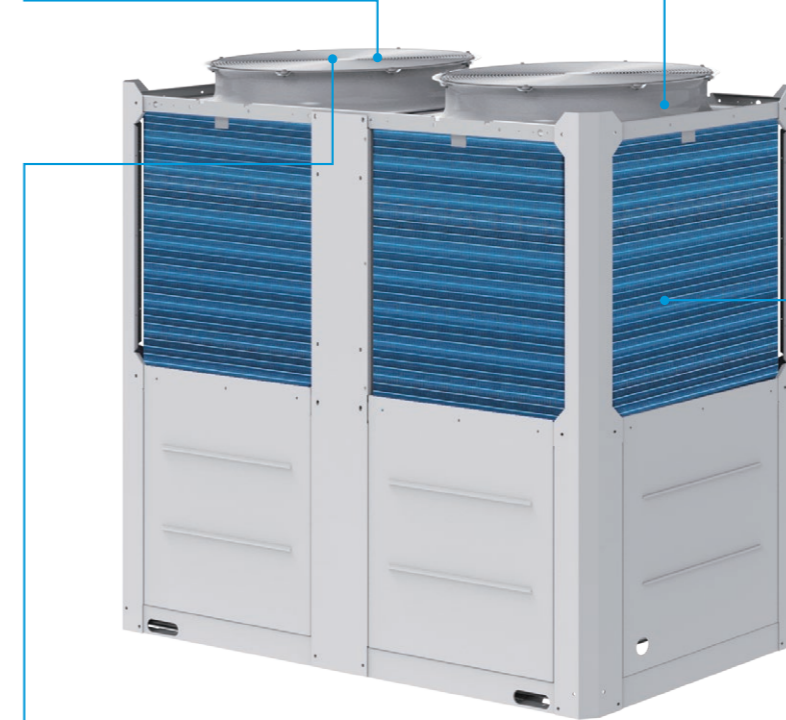

Blade trailing edge dentate structure design
Blade suction surface concave design
Reduced turbulent kinetic energy

Large blade front edge bending sweep design
Blade outer edge falling vorticity design

Blade installation angle optimization design
Improve airflow and fan efficiency

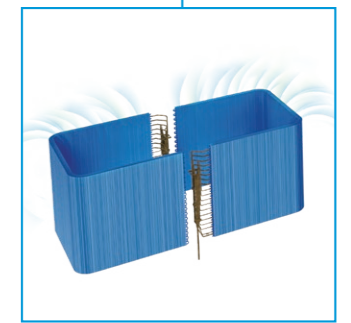

- Big heat exchanger area
- Located in the upper part
- Uniform air flow
- High efficient "Double U" heat exchanger

Comfortable and convenient to use

Convenient control

Three user levels

Three different user levels ensure users can easily access control functions and allow engineers convenient access to operating parameters.

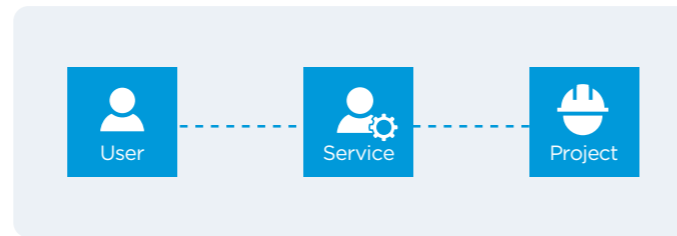

LCD touch wire controller

- Dot matrix LCD screen
- Weekly time, daily time
- Double temperature point setting
- Energy saving curve/power limiting mode setting
- Mute mode setting
- Power failure memory function
- Master/slave wire controller Settings
- Buzzer sound and alarm function
- Standard Modbus function, access to the smart building system



Multiple silent modes

By adjusting the frequency and speed of the fan, a variety of mute modes can be realized, and the silent mode reduces noise by 4 dB, the super silent mode reduces noise by 8 dB.

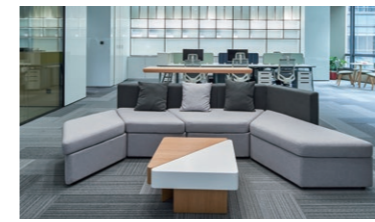
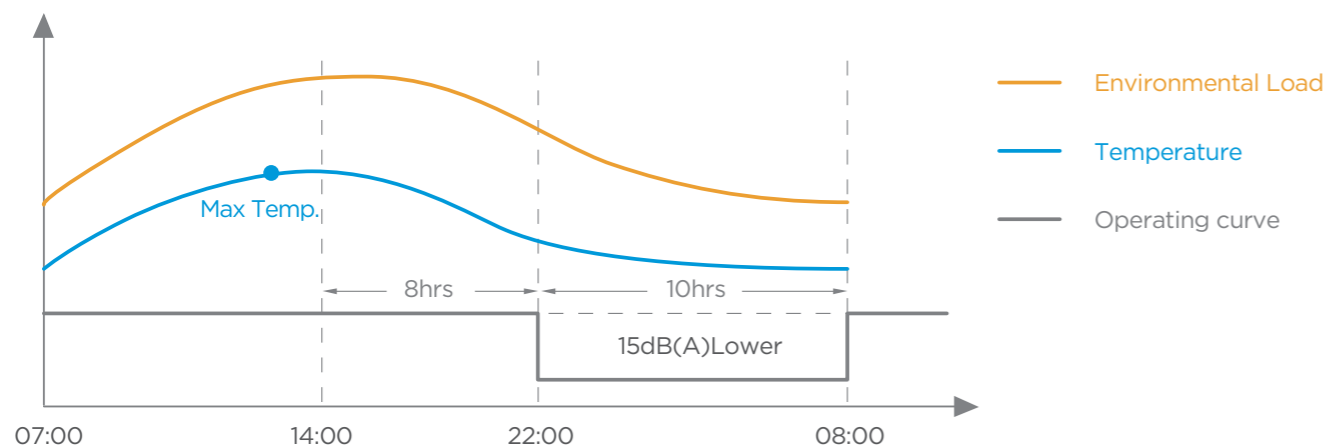

Standard mode



Silent mode



Super silent mode

Night silent mode

The night silent mode can be set by the online controller to meet the needs of low noise operation.



Adaptive variable temperature control and temperature regulation

According to different application scenarios, different terminals are used to adjust the temperature difference to the optimal target water temperature difference. The unit automatically adjusts the target water outlet temperature according to the outdoor environment temperature.

Ensure the comfort of users while realizing high efficiency and energy saving.

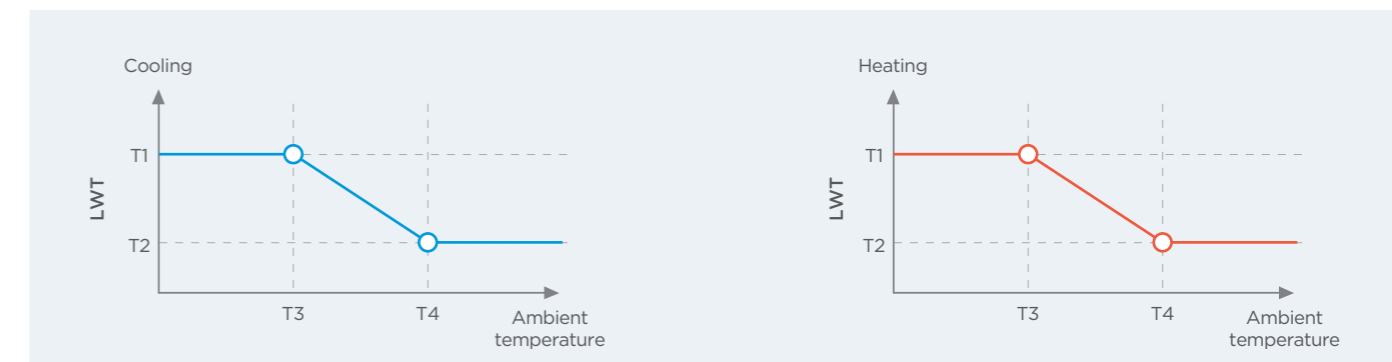
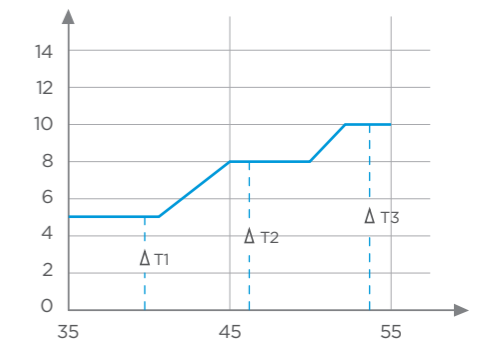

Intelligent alternate defrosting

The intelligent defrosting program calculates the time required for defrosting according to the actual system status, eliminating heat losses from unnecessary defrosting. A specialized defrosting valve reduces time required for defrosting to as little as four minutes. By detecting the water temperature, the proportion of defrosting unit can be determined intelligently so as to realize small water temperature fluctuation during the alternate defrosting period.

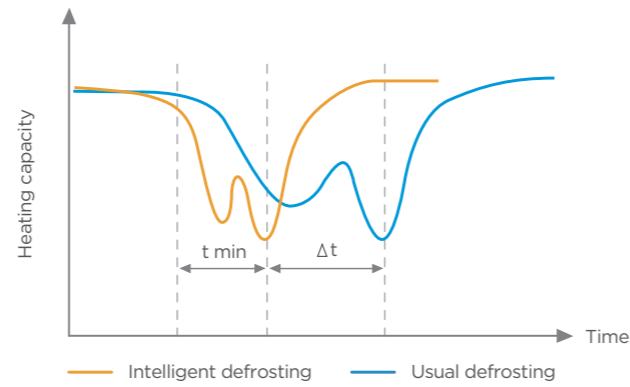

Remote alarm, on/off control, cooling/heating control

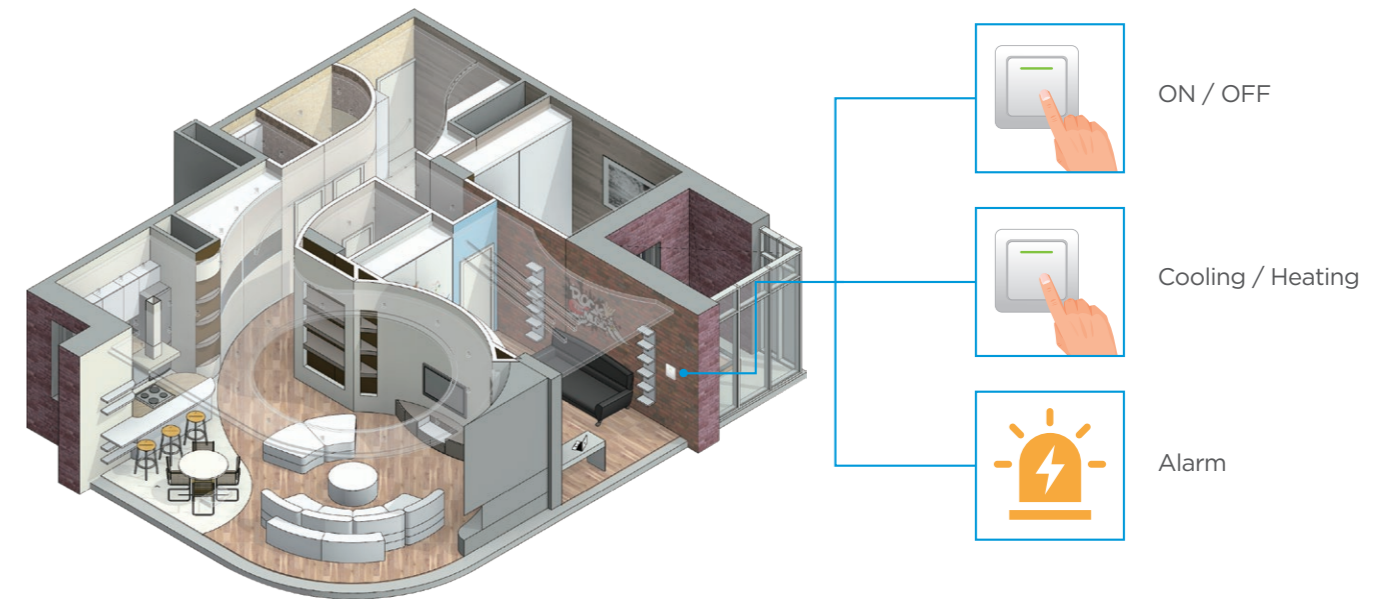

One-touch water temperature switching

For cooling and heating mode, different water temperatures can be switched just by one-touch.

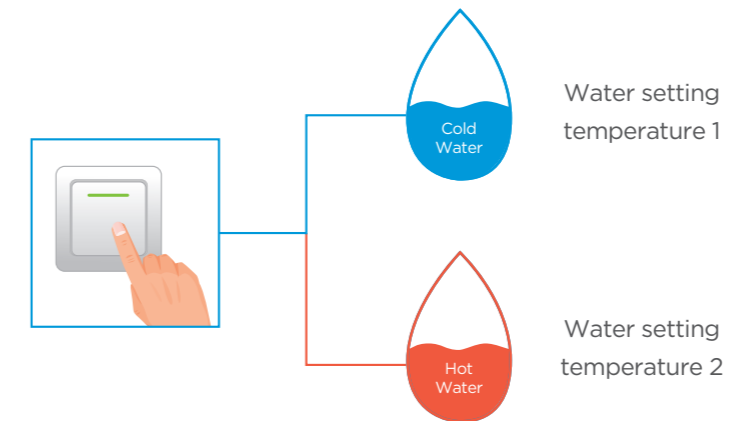

Convenient control

- Group control for up to maximum 16 units with one controller.
- Maximum 16 controllers 256 units can be connected to BMS system.

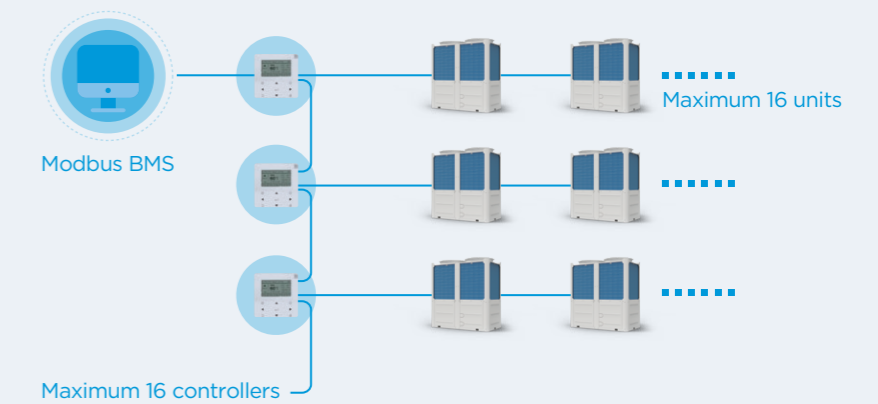

Easy installation and maintenance

Easy installation

Single unit covers an area of only 1.92m², which greatly saves lots of space for group control.

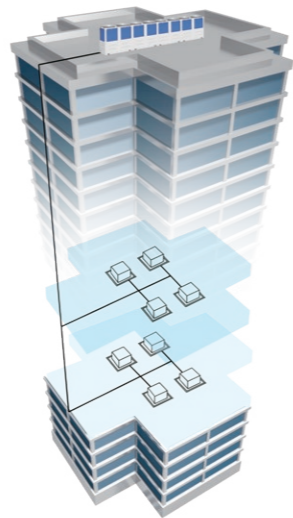
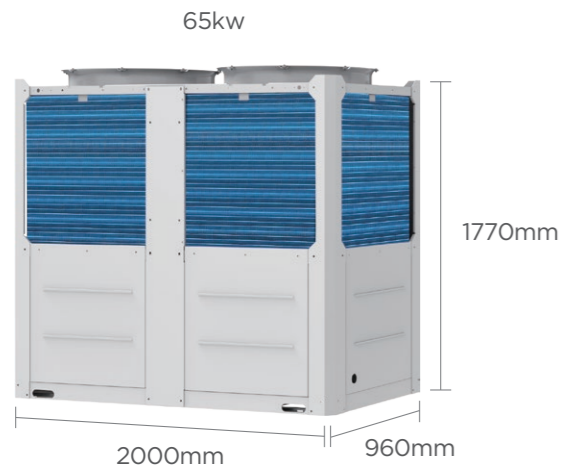

- The hydraulic models(customized) has the water pump components inside the unit, which can save the installation cost and time and make installation easier.
- Standard comes with a variety of components that are easy to install and maintain.

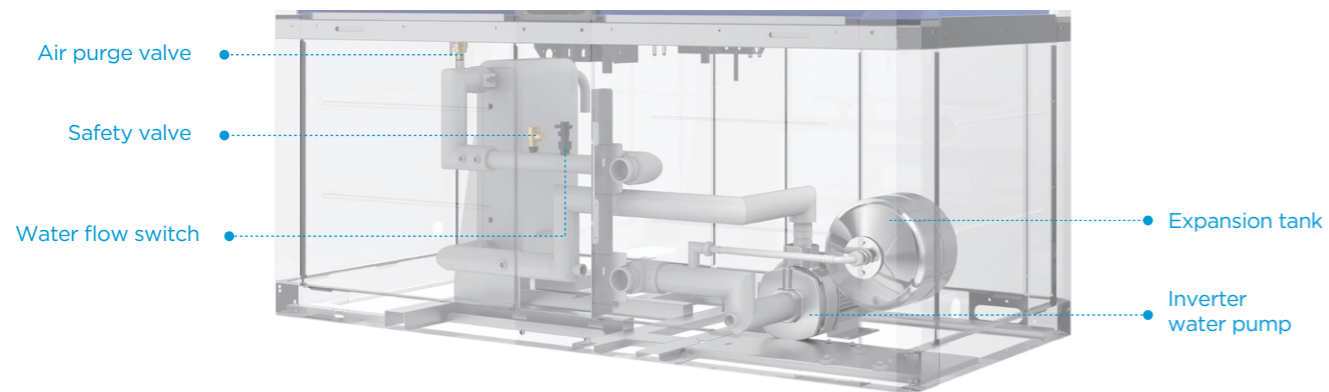

Alternative cycle duty operation

In one combination system, all units operate as alternative in cycle duty to keep equal running time, realize higher stability, better reliability and longer lifespan.

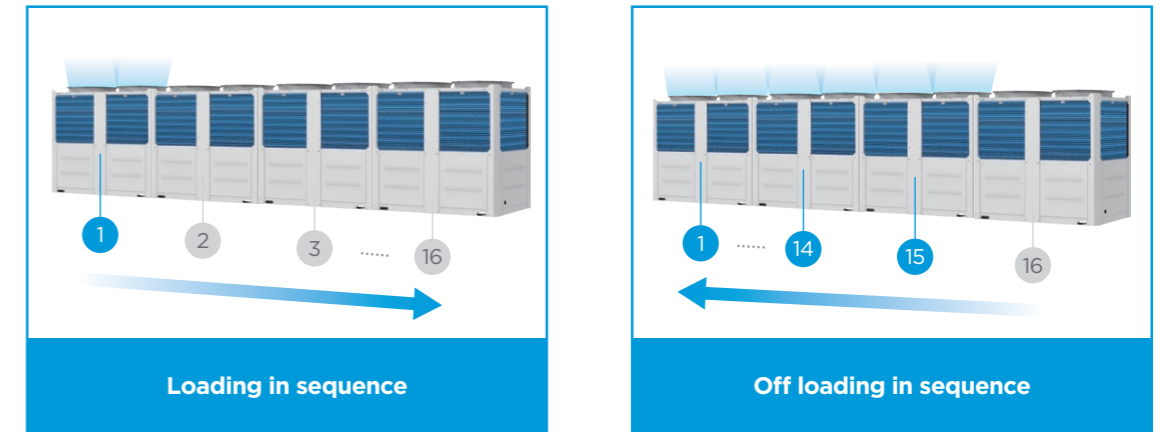

Back-up function

In a combination system, if one unit failed, other units can be back-up instead of the failed one for continuing operation.

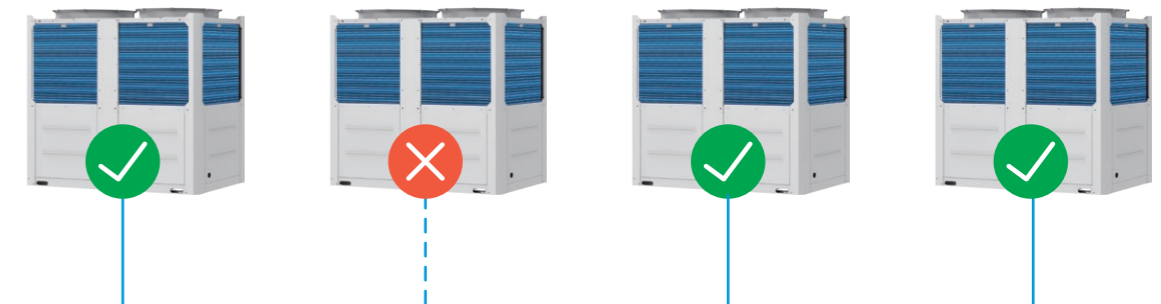

Convenient program upgrade

No need to carry any other heavy equipment but only USB can realize program upgrade of indoor unit and outdoor unit.



Specifications

Model name			MDVM-V65D2BR8-AS	MDVM-V75D2BR8-AS	MDVM-V110D2BR8-AS	MDVM-V140D2BR8-AS
Power supply		V/Ph/Hz	380-415/3/50			
Heating (A7W65)	Capacity	kW	60	61	100	110
	Rated input	kW	26.10	26.75	42.90	50.00
	COP	/	2.30	2.28	2.33	2.20
Heating (A7W55)	Capacity	kW	64	66	106	126
	Rated input	kW	21.33	22.15	35.30	49.22
	COP	/	3.00	2.98	3.00	2.56
Heating (A7W45)	Capacity	kW	65	75	110	140
	Rated input	kW	18.30	22.06	29.90	44.73
	COP	/	3.55	3.40	3.68	3.13
Heating (A7W35)	Capacity	kW	64	77	112	142
	Rated input	kW	15.24	19.74	27.00	38.17
	COP	/	4.20	3.90	4.15	3.72
SCOP (55) average		/	3.40	3.40	3.25	3.25
SCOP (35) average		/	4.50	4.50	4.25	4.25
Cooling (A35W7)	Capacity	kW	57	70	100	130
	Rated input	kW	19.00	26.80	32.78	50.00
	EER	/	3.00	2.61	3.05	2.60
Cooling (A35W18)	Capacity	kW	76	86	128	138
	Rated input	kW	20.27	23.12	33.70	36.32
	EER	/	3.75	3.72	3.80	3.80
SEER		/	5.00		4.80	
Air side heat exchanger	Type	/	Fin coil mode			
Fan	Type	/	DC motor			
	Air flow rate	m ³ /h	22000	28500	32500	50000
Water side heat exchanger	Type	/	Plate heat exchanger			
	Water pressure drop	kPa	44	65	39	65
Refrigerant system	Refrigerant type	/	R32			
	Refrigerant charge	kg	9		15.5	
	Throttle type	/	Electronic expansion valve			
Sound power level (A7W45)		dB	80	86	80	92
Sound pressure level (1m) (A7W45)		dB(A)	64	69	64	73
Net dimensions (W×H×D)		mm	2000 × 1770 × 960		2220 × 2300 × 1135	
Packed dimensions (W×H×D)		mm	2085 × 1890 × 1030		2250 × 2445 × 1180	
Net weight		kg	440		670	
Gross weight		kg	455		690	
Water pipe connections		mm	DN50		DN65	
Operating temperature	Cooling	°C	-15 to 48			
	Heating	°C	-25 to 43			
	DHW	°C	-20 to 43			
Water outlet temperature	Cooling ¹	°C	0 to 20			
	Heating	°C	25 to 65			
	DHW(Heat pump)	°C	30 to 62			
	DHW(Heat pump+Electric heater ²)	°C	30 to 70			

Notes:

1. Antifreeze liquid is needed when water outlet temperature reaches 5°C.
2. Electric heater installed in the tank is field supplied.

