

# Content

1. OUTDOOR UNITS LINEUP .....	2
2. NOMENCLATURE .....	3
3. FEATURES .....	4
4. DESCRIPTION OF MAIN COMPONENTS .....	7
5. SPECIFICATIONS .....	9
6. DIMENSIONS .....	13
7. PIPING DIAGRAM .....	14
8. WIRING DIAGRAM .....	15
9. ELECTRIC CHARACTERISTICS .....	18
10. CAPACITY TABLES .....	19
11. OPERATION LIMITS .....	26
12. HYDRAULIC DATA .....	28
12.1 USEFUL PUMP HEAD CURVES .....	28
12.2 WATER SIDE WATER PRESSURE DROP .....	29
13. SOUND LEVEL .....	32
14. EXPLODED VIEW .....	33
15. INSTALLATION .....	39
16. CHECKING AND STARTING UP THE UNIT .....	52
17. RUNNING AND MAINTENANCE .....	54
18. CONTROLLER .....	57
19. TROUBLESHOOTING .....	68
20. ACCESSORIES .....	80
21. OPTIONAL ACCESSORIES .....	80
22. APPENDIX .....	81

※ Manufacture reserves the right to discontinue, or change at any time, specifications or designs without notices and without incurring obligations.

## 1. Outdoor units lineup



**MGC-V5W/D2N1, MGC-V7W/D2N1**

Model	Power Supply (V/Ph/Hz)	Capacity	Compressor type	Heat exchanger	Refrigerant
MGC-V5W/D2N1	220-240/1 /50	5.0kW	DC Inverter	Plate type	R410A
MGC-V7W/D2N1	220-240/1/50	7.0kW	DC Inverter	Plate type	R410A



**MGC-V10W/D2N1, MGC-V12W/D2N1,  
MGC-V12W/D2RN1, MGC-V14W/D2RN1, MGC-V16W/D2RN1**

Model	Power Supply (V/Ph/Hz)	Capacity	Compressor type	Heat exchanger	Refrigerant
MGC-V10W/D2N1	220-240/1/50	10.0	DC Inverter	Plate type	R410A
MGC-V12W/D2N1	220-240/1/50	11.2	DC Inverter	Plate type	R410A
MGC-V12W/D2RN1	380-415/3/50	11.2	DC Inverter	Plate type	R410A
MGC-V14W/D2RN1	380-415/3/50	12.5	DC Inverter	Plate type	R410A
MGC-V16W/D2RN1	380-415/3/50	14.5	DC Inverter	Plate type	R410A

## 2. Nomenclature

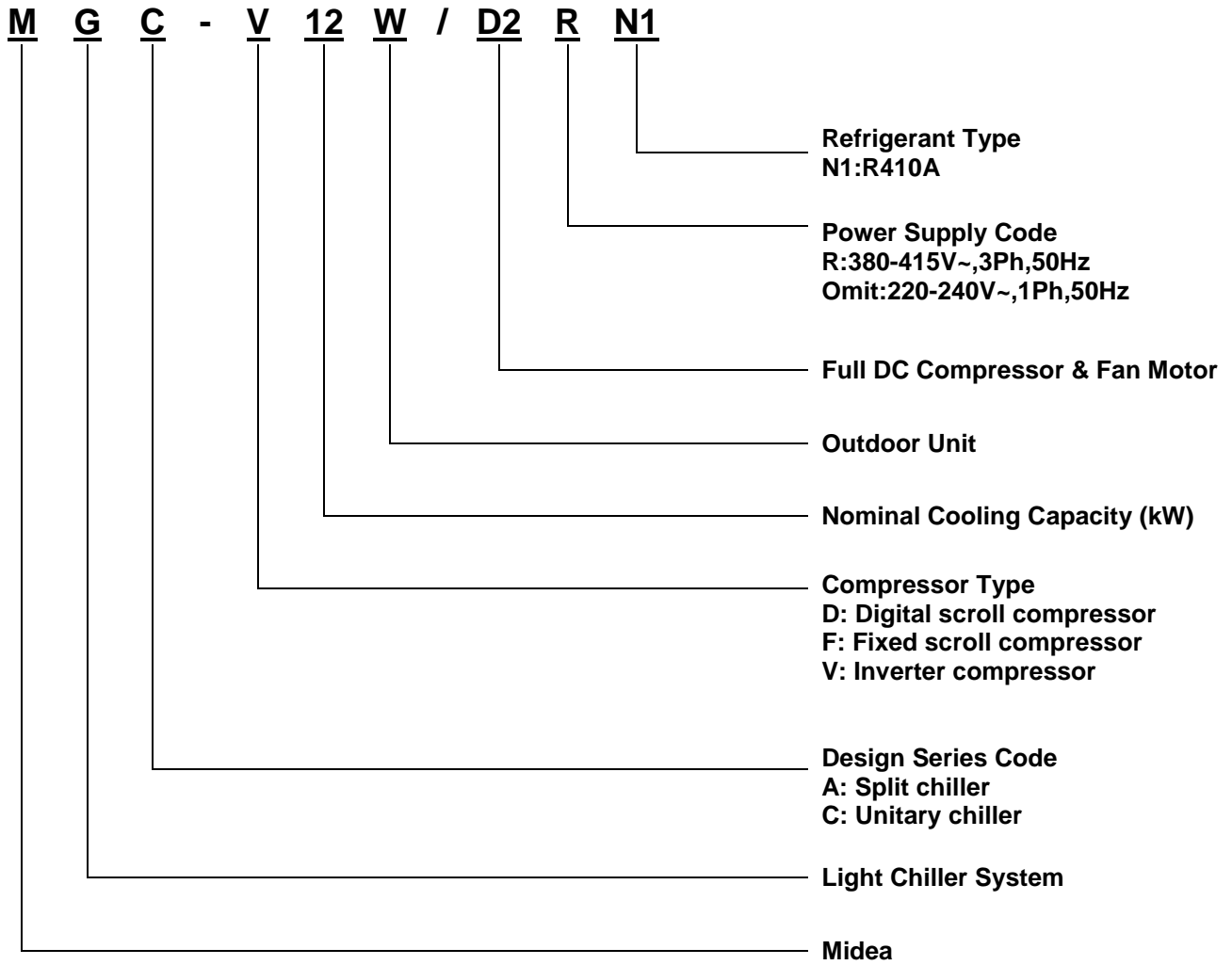

### 3. Features

#### 3.1 High efficient DC inverter compressor

DC inverter Mini chiller adopts highly intelligent inverter-driven compressor. This advanced technology enables the output of the outdoor unit to be modulated by the real heat load demands. This advanced system ensures precise temperature regulation and highly efficient energy usage, making a significant contribution to limiting the impact on the environment.

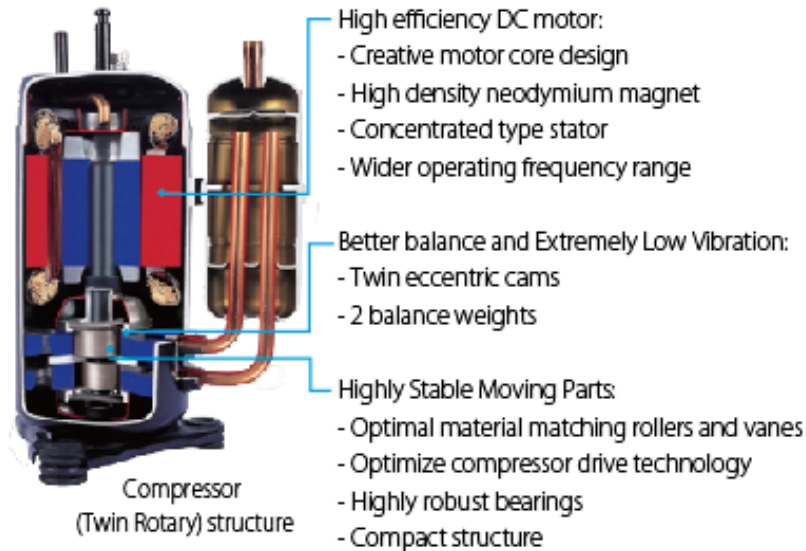

#### 3.2 High performance heat exchanger

The new designed window fins enlarge the heat-exchanging area, which decrease the air resistance, save more power and enhance heat exchange performance.

Hydrophilic film fins and inner-threaded copper pipes optimize heat exchange efficiency.

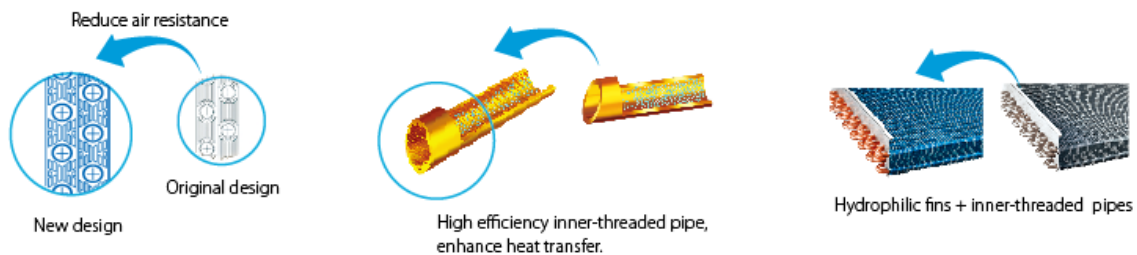

#### 3.3 A<sup>+</sup> rated energy efficiency

The DC inverter chiller integrates the latest technological innovations and ensures precise temperature regulation and highly efficient energy usage, making a significant contribution to the limiting the impact on the environment.

#### 3.4 Wide operation temperature range

Stable and safe running at wide ambient temperature range, cooling performance from -5 °C to 46°C, heating from -15°C to 27°C.

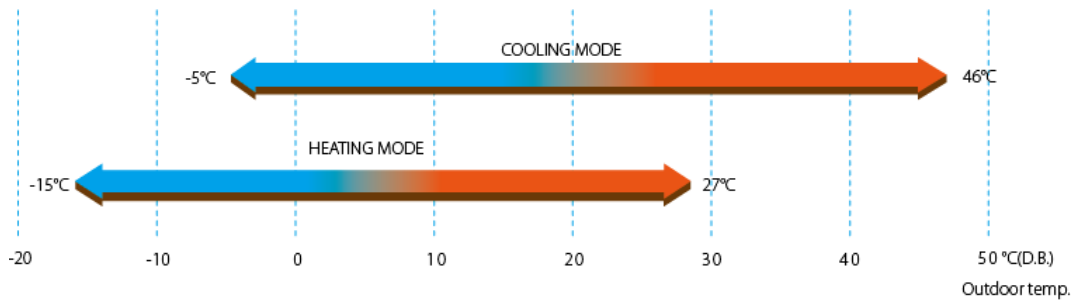

**3.5 Low-operating sound design**

Optimally design fan shape and new designed discharge air grille and air deflector, making higher air volume and reduces running noise.

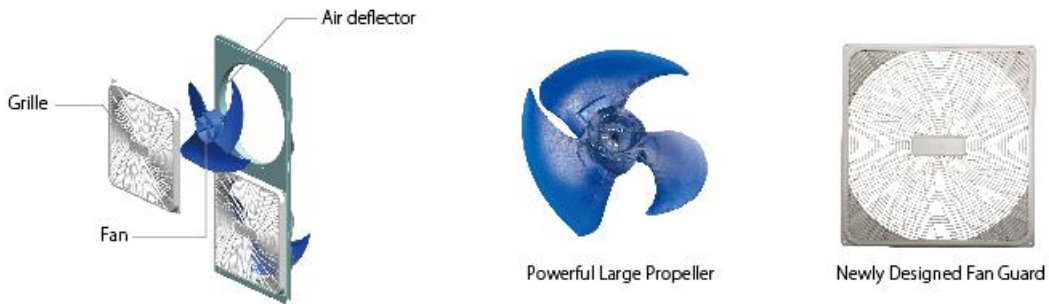

**3.6 Plate heat exchanger**

By adopting high efficiency plate heat exchanger, the energy consumption can be reduced.

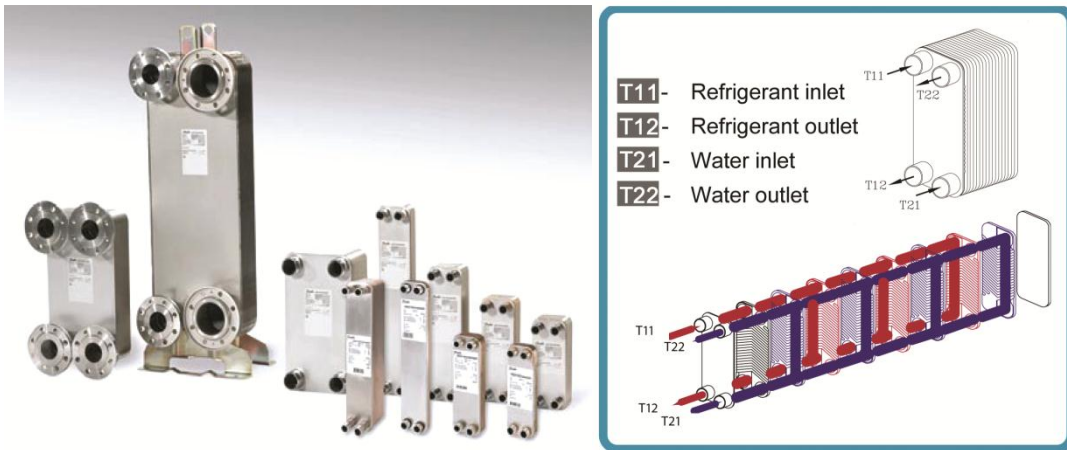

- a. Metallic protective cabinet with rustproof polyester paint;
- b. Built-in with voltage protection, current protection, anti-freezing protection, water flow protection and etc., effectively guarantee the system to work safely.

**3.7 User friendly remote control**

Switch SW4\_1(5-10kW) or SW3\_1(12-16kW) on the PCB to ON to enable the following remote control functions. The default setting at factory is not set remote control functions.

- Remote shut down
- Remote cooling and heating

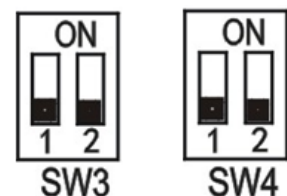

### 3.8 Flexible and convenient control

- Built-in electronic controller at factory.

Compact devices with advanced function and friendly user interface.



- The chiller can be controlled by wired controller (KJR-120F/BMK-E), which is optional.



Note: When connecting wired controller, outdoor unit control panel is mainly used for display, check parameters and diagnosis function. It can't be used to set mode and adjust temperature.

- Built-in water pressure gauge for inspecting the water pressure all the time.

### 3.9 Integrated and compact design

Hydraulic module, such as expansion tank, plate type of heat exchanger, water circulating pump is built-in the outdoor unit. The integrated structure design saves installation space and cost.

### 3.10 EXV control flow more precisely

Patented liquid distribution components to maximize performance and minimize defrost impact.

EXV adopted for stable and accurate gas flow control. EXV achieves 500 pulses to adjust flow precisely.

Ensure the temperature-control precisely and steadily to provide a comfortable environment.

Fast respond resulting in higher efficiency and improved reliability.

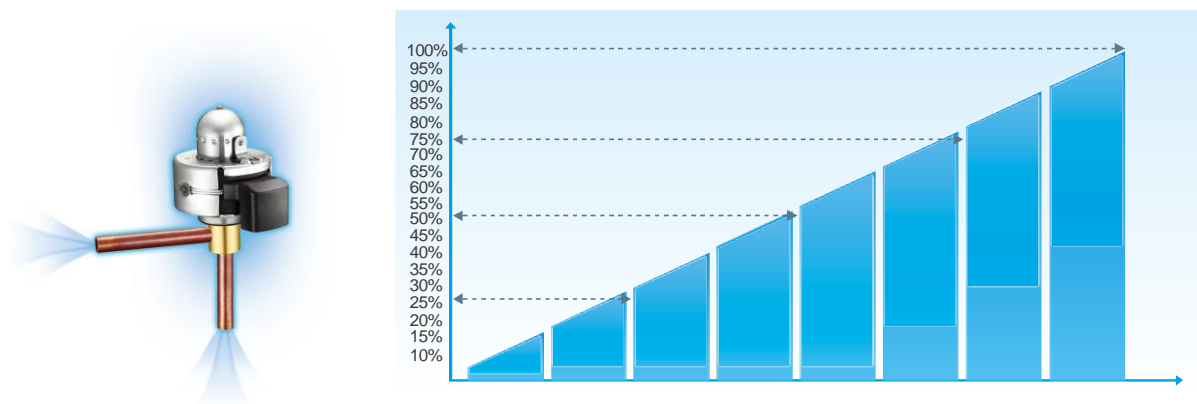

### 3.11 Water pump starts/stops compulsory function

Press "Check" button for 3 seconds to start the water pump operating when the unit is standby.

Press "Check" button for 3 seconds again to stop the water pump.

## 4. Description of main components

### **Structure:**

Panels and base are made from galvanized steel plate painted with epoxy powder to ensure total resistance to atmospheric pollution, condensate collection pan as standard.

### **Condenser coils:**

The coils are made from high performance and seamless copper tube and high surface area aluminum fins to ensure optimum heat exchange capability. Condenser coil protection grill is standard.

### **Fan motor:**

To achieve high efficiency heat exchange, the unit is equipped with the high performance axial-flow fans. The fan is driven directly by weather proof motor to ensure reliable operation; the fan motor is six-pole electric motor with built-in thermal cut-out.

### **Evaporator:**

The heat exchanger is made of AISI 316 stainless steel to ensure high heat exchange efficiency, complete with electric heater and differential pressure switch. The complete heat exchanger is insulated with thermal insulation closed cell rubber foam to give optimum thermal insulation.

### **Hydraulic module:**

It is fully integrated and equipped with key hydraulic components such as expansion tank, plate type of heat-exchanger, water circulating pump.

The water pressure differential switch is provided in the units to protect against damage to the water pump.

### **Power and control electrical panel:**

Power and control electrical panel constructed in accordance with IEC 204-1/EN60335-2-40, complete with compressor contactor, control via control panel.

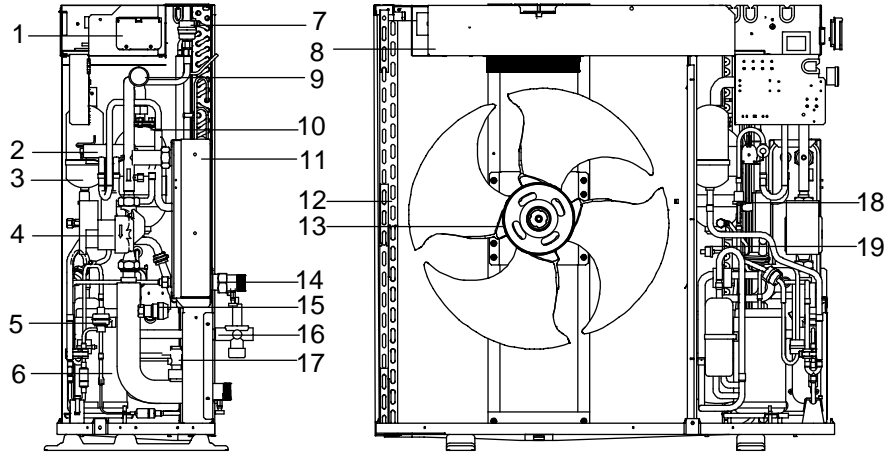

**5/7KW**

- |                             |                                   |
|-----------------------------|-----------------------------------|
| 1 Operation panel           | 10 Expansion tank                 |
| 2 4-ways valve              | 11 Plate heat exchanger           |
| 3 Storage tank              | 12 Condenser                      |
| 4 Pump                      | 13 Axial-flow fan                 |
| 5 Electric expansive valve  | 14 Adapter substitute (accessory) |
| 6 Compressor                | 15 Security discharge             |
| 7 Automatic discharge valve | 16 Water supply valve (accessory) |
| 8 Electrical panel          | 17 Water flow switch              |
| 9 Water manometer           | 18 High pressure switch           |
|                             | 19 Low pressure switch            |

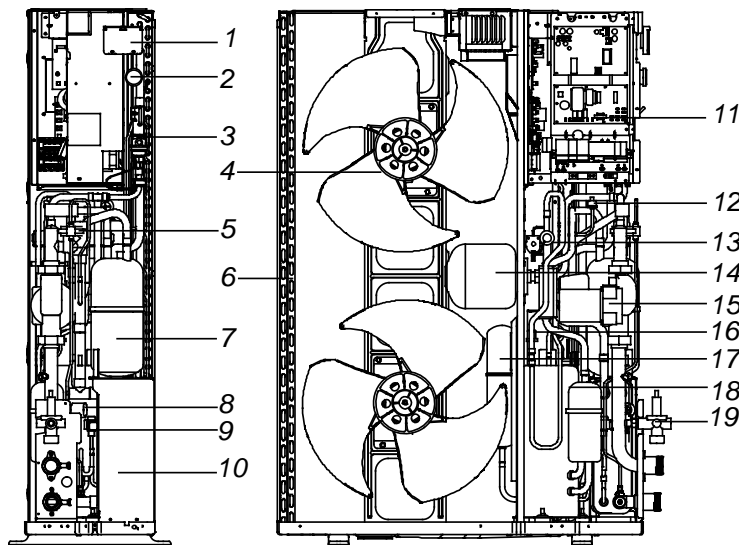

**10~16KW**

- |                                |                         |
|--------------------------------|-------------------------|
| 1 Operation panel              | 11 Electrical panel     |
| 2 Water manometer              | 12 High pressure switch |
| 3 Automatic discharge valve    | 13 4-ways valve         |
| 4 Axial-flow fan               | 14 Expansion tank       |
| 5 Differential pressure switch | 15 Pump                 |
| 6 Condenser                    | 16 Low pressure switch  |
| 7 Accumulator                  | 17 Storage tank         |
| 8 Security discharge           | 18 Compressor           |
| 9 Electric expansive valve     | 19 Water supply valve   |
| 10 Plate heat exchanger        |                         |



## 5. Specifications

### 220-240/1/50

Model			MGC-V5W/D2N1	MGC-V7W/D2N1	MGC-V10W/D2N1	MGC-V12W/D2N1
Power supply		V/Ph/Hz	220-240/1/50	220-240/1/50	220-240/1/50	220-240/1/50
Cooling <sup>1</sup>	Capacity	kW	5.0(1.9~5.8)	7.0(2.1~7.8)	10.0(2.9~10.5)	11.2(3.1~12.0)
	rated Input	W	1550	2250	2950	3500
	rated current	A	6.8	9.9	13.0	15.4
	EER	W/W	3.23	3.11	3.39	3.20
Cooling <sup>2</sup>	Capacity	kW	5.6	8.0	10.6	12.2
	rated Input	W	1150	1850	2300	2650
	EER	W/W	4.87	4.32	4.24	4.60
	SEER		5.83	6.07	5.71	6.37
Heating <sup>3</sup>	Capacity	kW	6.2(2.1~7.0)	8.0(2.3~9.0)	11.0(3.2~12.0)	12.3(3.3~13.2)
	rated Input	W	1900	2500	3140	3780
	rated current	A	8.3	11.0	13.8	16.6
	COP	W/W	3.26	3.20	3.50	3.25
Heating <sup>4</sup>	Capacity	kW	6.2	8.6	11.5	13.0
	rated Input	W	1350	2100	2650	2920
	COP	W/W	4.60	4.10	4.34	4.45
	SCOP		3.55	3.46	3.34	3.46
Seasonal space heating energy efficiency ( $\eta_s$ )			138.9%	135.3%	130.7%	135.4%
Seasonal space heating energy efficiency class			A <sup>+</sup>	A <sup>+</sup>	A <sup>+</sup>	A <sup>+</sup>
Max. input current		A	11.4	13.7	25	19.1
Compressor	Model		SNB172FJGMC	SNB172FJGMC	ATQ420D1UMU	ATQ420D1UMU
	Type		Rotary	Rotary	Rotary	Rotary
	Brand		Mitsubishi Electric	Mitsubishi Electric	GMCC	GMCC
	Capacity	kW	5.46	5.46	13.1	13.1
	Input	kW	1.64	1.64	3.42	3.42
	Rated load current	A	8.1	8.1	6.85	6.85
	Locked rotor Amp	A	29.5	29.5	52	52
	Thermal protector		Inner	Inner	Inner	Inner
Refrigerant oil	mL	FV50S,400	FV50S,400	VG74,1400	VG74,1400	
Outdoor fan	Model		WZDK170-38G-1	WZDK170-38G-1	WZDK100-38G	WZDK100-38G
	Type		DC Motor	DC Motor	DC Motor	DC Motor
	Brand		Nidec Shibaura	Nidec Shibaura	Panasonic	Panasonic
	Input	W	170	170	100	100
	Speed	r/min	820	820	800	800
	Air flow	m <sup>3</sup> /h	5100	5100	7000	7000
Air heat exchanger	Number of rows		2	2	2	2
	Tube pitch(a)x row pitch(b)	mm	22x19.05	22x19.05	22x19.05	22x19.05
	Fin spacing	mm	1.6	1.6	1.6	1.6
	Fin type		Hydrophilic aluminum foil			
	Tube outside dia. and type	mm	$\phi$ 7.94	$\phi$ 7.94	$\phi$ 7.94	$\phi$ 7.94
			Inner grooved copper tube			
	Coil length xheight		885x880	885x880	1276x870	1276x870
Number of circuits		6	6	7	7	

Model			MGC-V5W/D2N1	MGC-V7W/D2N1	MGC-V10W/D2N1	MGC-V12W/D2N1
Water heat exchanger	Type		Plate heat exchanger			
	Model		ACH-30EQ-38H-F	ACH-30EQ-38H-F	ACH-30EQ-50H-F	ACH-30EQ-56H-F
	Circuits	Quantity	19	19	25	28
	Water volume	L	0.53	0.53	0.7	0.78
	Water flow	m <sup>3</sup> /h	0.86	1.20	1.72	1.92
	Water pressure drop	kPa	15	15	18	18
Water pump	Type		RS15/6 RKC	RS15/6 RKC	RS25/7.5 RKC	RS25/7.5 RKC
	Pump head	m	5.5	5.5	7.5	7.5
	Water volume	L/min	4	4	4	4
	Input (H/M/L)	W	93/67/46	93/67/46	210/175/120	210/175/120
Expansion tank volume		L	2	2	3	3
Refrigerant	Type		R410A	R410A	R410A	R410A
	Charged volume	kg	2.5	2.5	2.8	2.8
Throttle type			Electronic expansion valve			
Sound power level <sup>5</sup>		dB(A)	63	66	68	68
Sound pressure level		dB(A)	58	58	59	59
Unit net dimension (W×H×D)		mm	990×966×354	990×966×354	970×1,327×400	970×1,327×400
Packing dimension (W×H×D)		mm	1,120×1,100×435	1,120×1,100×435	1,082×1,456×435	1,082×1,456×435
Net/ Gross weight		kg	81/91	81/91	110/121	110/121
The Max. and Min. water inlet pressure <sup>6</sup>		kPa	500/150	500/150	500/150	500/150
Pipe connections	Water inlet/outlet	inch	1"	1"	1-1/4"	1-1/4"
Connection wiring	Power wire	mm <sup>2</sup>	3×2.5	3×2.5	3×4.0	3×4.0
	Signal wire	mm <sup>2</sup>	3×0.75	3×0.75	3×0.75	3×0.75
Controller			Electronic controller (standard), wired controller (optional)			
Ambient temperature range	Cooling	°C	-5~46	-5~46	-5~46	-5~46
	Heating	°C	-15~27	-15~27	-15~27	-15~27
Water outlet temperature range	Cooling	°C	4~20	4~20	4~20	4~20
	Heating	°C	30~55	30~55	30~55	30~55

Nominal capacity is based on the following conditions:

1. Condenser air in 35°C. Evaporator water in/out 12/7°C
2. Condenser air in 35°C. Evaporator water in/out 23/18°C
3. Evaporator air in 7°C °C85% R.H., Condenser water in/out 40/45°C
4. Evaporator air in 7°C °C85% R.H., Condenser water in/out 30/35°C
5. At 1m in open field fan side (sound pressure)
6. The maximum and minimum operating pressure values refer to the activation of the pressure switches
7. The above data test reference standard EN14511:2013; EN14825:2013; EN50564:2011; EN12102:2011; (EU)No:811:2013; (EU)No:813:2013; OJ 2014/C 207/02:2014

**380-415/3/50**

Model			MGC-V12W/D2RN1	MGC-V14W/D2RN1	MGC-V16W/D2RN1
Power supply		V/Ph/Hz	380-415/3/50	380-415/3/50	380-415/3/50
Cooling <sup>1</sup>	Capacity	kW	11.2(3.1~12.0)	12.5(3.3~14.0)	14.5(3.5~15.5)
	rated Input	W	3380	3900	4700
	rated current	A	5.5	6.4	7.7
	EER	W/W	3.31	3.20	3.10
Cooling <sup>2</sup>	Capacity	kW	12.2	14.2	15.6
	rated Input	W	2600	3100	3600
	EER	W/W	4.70	4.58	4.33
	SEER		6.18	6.69	6.78
Heating <sup>3</sup>	Capacity	kW	12.3(3.3~13.2)	13.8(3.5~15.4)	16.0(3.7~17.0)
	rated Input	W	3720	4250	4850
	rated current	A	6.1	7.0	8.0
	COP	W/W	3.31	3.25	3.30
Heating <sup>4</sup>	Capacity	kW	13.0	15.1	16.5
	rated Input	W	2850	3350	3920
	COP	W/W	4.56	4.51	4.21
	SCOP		3.66	3.78	3.39
Seasonal space heating energy efficiency ( $\eta_s$ )			143.5%	148.3%	132.6%
Seasonal space heating energy efficiency class			A <sup>+</sup>	A <sup>+</sup>	A <sup>+</sup>
Max. input current		A	8.9	9.6	10.1
Compressor	Model		ATQ420D1UMU	ATQ420D2UMU	ATQ420D2UMU
	Type		Rotary	Rotary	Rotary
	Brand		GMCC	GMCC	GMCC
	Capacity	kW	13.1	13	13
	Input	kW	3.42	3.45	3.45
	Rated load current	A	6.85	6.9	6.9
	Locked rotor Amp	A	52	44	44
	Thermal protector		Inner	Inner	Inner
Refrigerant oil	mL	VG74,1400	VG74,1400	VG74,1400	
Outdoor fan	Model		WZDK100-38G	WZDK100-38G	WZDK100-38G
	Type		DC Motor	DC Motor	DC Motor
	Brand		Panasonic	Panasonic	Panasonic
	Input	W	100	100	100
	Speed	r/min	800	800	800
	Air flow	m <sup>3</sup> /h	7000	7000	7000
Air heat exchanger	Number of rows		2	2	2
	Tube pitch(a)× row pitch(b)	mm	22×19.05	22×19.05	22×19.05
	Fin spacing	mm	1.6	1.6	1.6
	Fin type		Hydrophilic aluminum foil		
	Tube outside dia. and type	mm	φ7.94	φ7.94	φ7.94
	Coil length xheight		1276×870	1276×870	1276×870
	Number of circuits		7	7	7

Model			MGC-V12W/D2RN1	MGC-V14W/D2RN1	MGC-V16W/D2RN1
Water heat exchanger	Type		Plate heat exchanger	Plate heat exchanger	Plate heat exchanger
	Model		ACH-30EQ-56H-F	ACH-30EQ-64H-F	ACH-30EQ-70H-F
	Circuits	Quantity	28	35	38
	Water volume	L	0.78	0.78	1.06
	Water flow	m <sup>3</sup> /h	1.92	2.15	2.49
	Water pressure drop	kPa	18	18	19
Water pump	Type		RS25/7.5 RKC	RS25/7.5 RKC	RS25/7.5 RKC
	Pump head	m	7.5	7.5	7.5
	Water volume	L/min	4	4	4
	Input (H/M/L)	W	210/175/120	210/175/120	210/175/120
Expansion tank volume		L	3	3	3
Refrigerant	Type		R410A	R410A	R410A
	Charged volume	kg	2.8	2.9	3.2
Throttle type			Electronic expansion valve		
Sound power level		dB(A)	68	70	72
Sound pressure level <sup>5</sup>		dB(A)	62	62	62
Unit net dimension (WxHxD)		mm	970×1,327×400	970×1,327×400	970×1,327×400
Packing dimension (WxHxD)		mm	1,082×1,456×435	1,082×1,456×435	1,082×1,456×435
Net/ Gross weight		kg	110/121	111/122	111/122
The Max. and Min. water inlet pressure <sup>6</sup>		kPa	500/150	500/150	500/150
Pipe connections	Water inlet/outlet	inch	1-1/4"	1-1/4"	1-1/4"
Connection wiring	Power wire	mm <sup>2</sup>	5×3.0	5×3.0	5×3.0
	Signal wire	mm <sup>2</sup>	3×0.75	3×0.75	3×0.75
Controller			Electronic controller (standard), wired controller (optional)		
Ambient temperature range	Cooling	°C	-5~46	-5~46	-5~46
	Heating	°C	-15~27	-15~27	-15~27
Water outlet temperature range	Cooling	°C	4~20	4~20	4~20
	Heating	°C	30~55	30~55	30~55

Nominal capacity is based on the following conditions:

1. Condenser air in 35°C. Evaporator water in/out 12/7°C
2. Condenser air in 35°C. Evaporator water in/out 23/18°C
3. Evaporator air in 7°C °C85% R.H., Condenser water in/out 40/45°C
4. Evaporator air in 7°C °C85% R.H., Condenser water in/out 30/35°C
5. At 1m in open field fan side (sound pressure)
6. The maximum and minimum operating pressure values refer to the activation of the pressure switches
7. The above data test reference standard EN14511:2013; EN14825:2013; EN50564:2011; EN12102:2011; (EU)No:811:2013; (EU)No:813:2013; OJ 2014/C 207/02:2014

### 6. Dimensions

MGC-V5W/D2N1,MGC-V7W/D2N1 (Unit: mm)

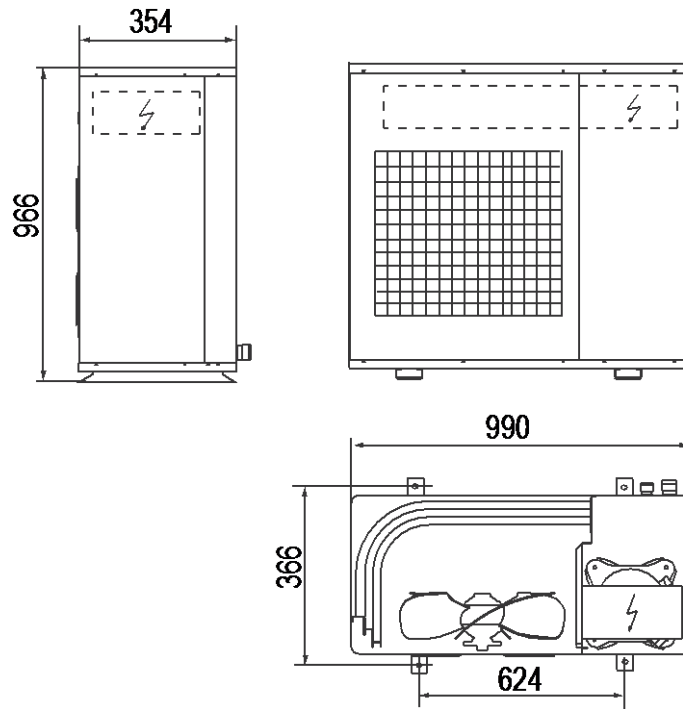

MGC-V10W/D2N1,MGC-V12W/D2RN1,MGC-V14W/D2RN1,MGC-V16W/D2RN1 (Unit: mm)

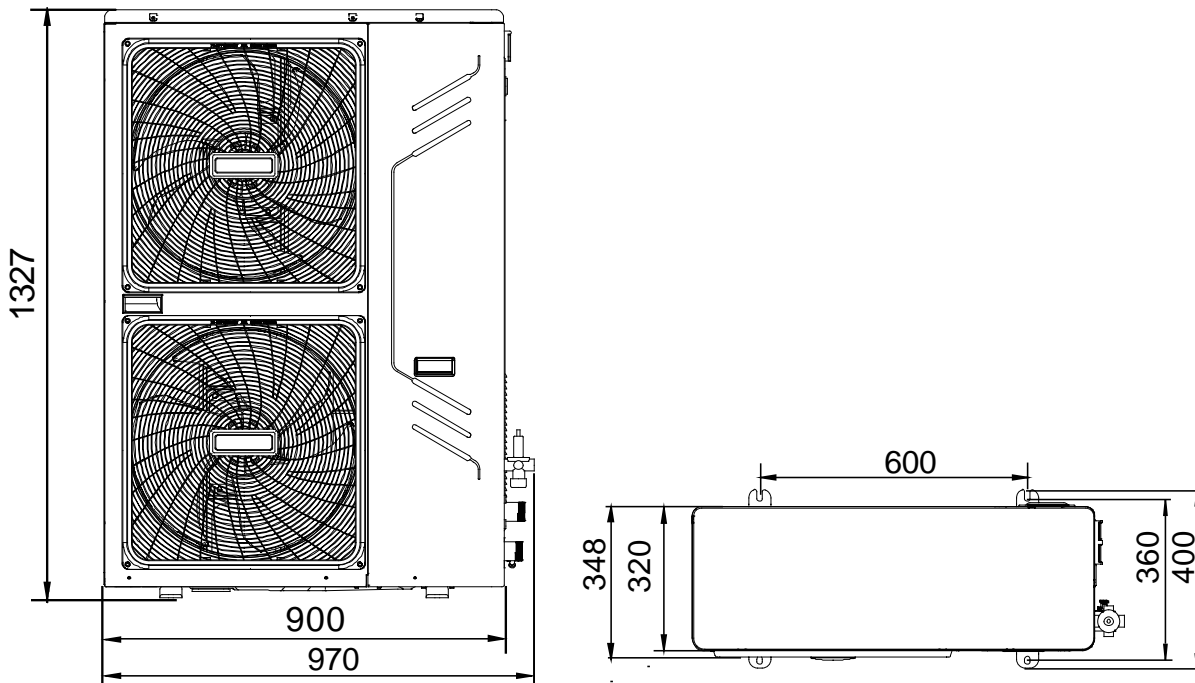

### 7. Refrigeran Cycle

#### MGC-V5W/D2N1, MGC-V7W/D2N1

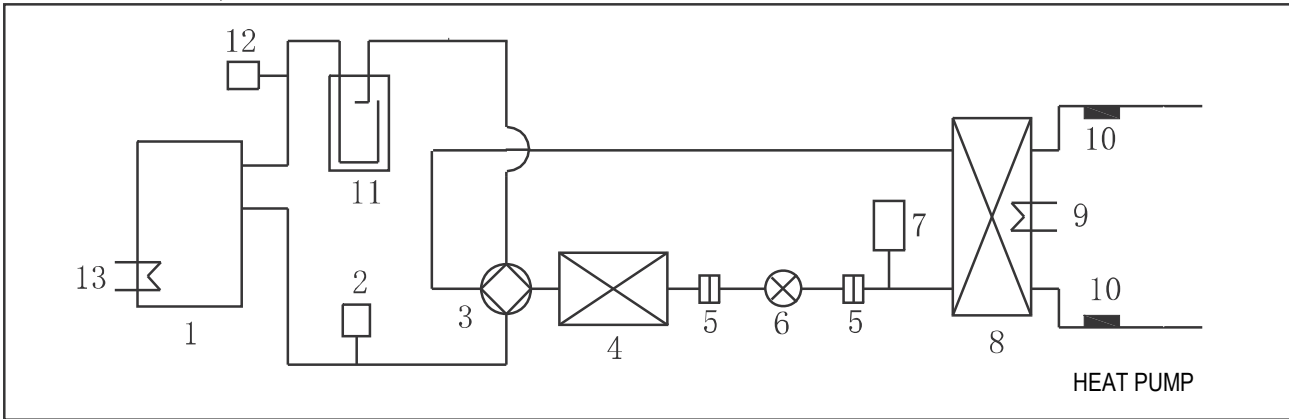

- |                               |                            |                        |
|-------------------------------|----------------------------|------------------------|
| 1 compressor                  | 6 electric expansive valve | 11 accumulator         |
| 2 high pressure switch        | 7 liquid receiver          | 12 low pressure switch |
| 3 4-way valve(only HEAP PUMP) | 8 plate heat exchanger     | 13 crankcase heater    |
| 4 condenser                   | 9 defrost heater           |                        |
| 5 filter                      | 10 water Temp. sensor      |                        |

#### MGC-V10W/D2N1, MGC-V12W/D2N1, MGC-V12W/D2RN1, MGC-V14W/D2RN1, MGC-V16W/D2RN1

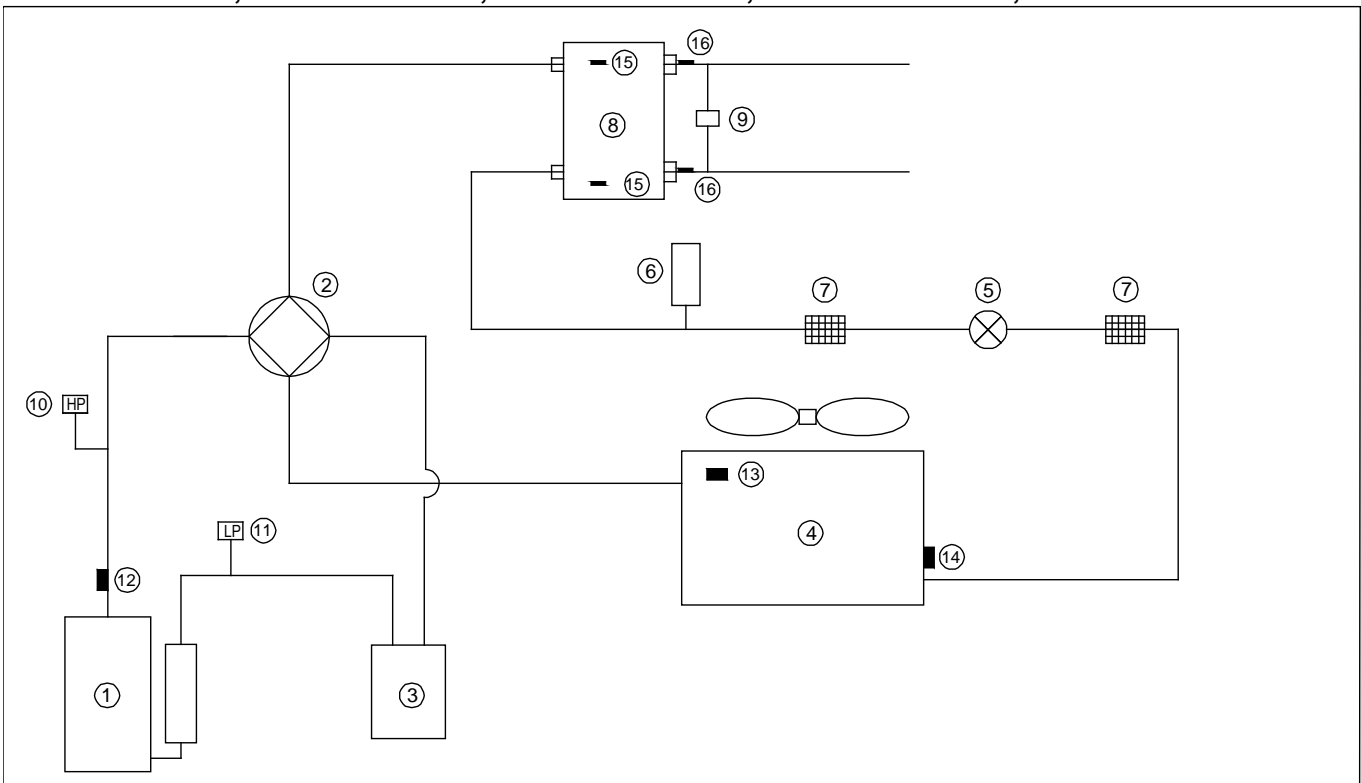

- |                              |                                |  |
|------------------------------|--------------------------------|--|
| 1 compressor                 | 7 filter                       | 12 Temp. sensor (discharge)            |
| 2 4-Way Valve                | 8 plate heat exchanger         | 13 Temp. sensor (ambient)              |
| 3 accumulator                | 9 differential pressure switch | 14 Temp. sensor (condenser)            |
| 4 condenser                  | 10 high pressure switch        | 15 Temp. sensor (plate heat exchanger) |
| 5 electronic expansion valve | 11 low pressure switch         | 16 water Temp. sensor                  |
| 6 liquid receive             |                                |  |

### 8. Wiring diagram

#### MGC-V5W/D2N1 & MGC-V7W/D2N1

202090490086

**MAIN CONTROL PANEL**

**PFC & IPM PANEL**

**DC Filter Panel**

**NOTE**

- The wire controller is optional. Please use 3-core shielded wire to connect the wire controller and the shielding layer must be grounded.
- "PUMP2" and "REMOTE ALARM" wiring terminal ports provide only the switch signal. The lead should be controlled through the AC controller.

CODE	PART NAME
COMP.	Compressor
CT1	AC current detector
EEV.	Electric Expansive Valve
FAN	Outdoor fan motor
CRANK	Compressor electric heating zone
CP_HEAT	Plate Heat Exchanger electric heating zone
FS_HEAT	Flow switch electric heating zone
EX_HEAT	Exhaust valve electric heating zone
H-PRO	High pressure switch
L-PRO	Low pressure switch
4-WAY	4-Way valve
T3	Condenser temperature sensor
T4	Outdoor ambient temperature sensor
Tp	Comp. Discharge temperature sensor
Tb1	Plate heat exchanger anti-freezing temperature sensor
Tin	Inlet water temperature sensor of heat exchanger
Tout	Outlet water temperature sensor of heat exchanger
XT1	14-Way terminal
F.S.	Flow switch

Checking No.	Meanings
0	The normal display
1	Frequency
2	Running mode 0-Shutdown, 1-The pump model, 2-Cooling, 3-Heating, 4-Forced cooling.
3	Fan speed 0-Shutdown, 1~7-Fan speed
4	Total capacity requirements
5	The revised capacity requirements
6	Cooling/heating temp. set
7	T3 temp. Value
8	T4 temp. Value
9	Tp temp. Value
10	Tin temp. Value

Display	Malfunction or Protection
E4	T3&T4 temperature sensor malfunction
E5	Voltage protection
E6	DC fan motor malfunction
E9	EEPROM malfunction
EA	5-minute error for heating mode fan in area A
Eb	Two times of E6 protection in 10 minutes
EC	Tout temperature sensor malfunction
C0	Tb1 temperature sensor malfunction
C1	Tb2 temperature sensor malfunction
C8	Flow switch malfunction
CH	Low water temperature protection in cooling mode
P8	Typhoon protection
H0	Communication malfunction between the main controlling chip and IPDU

Display	Malfunction or Protection
CL	High inlet and outlet water temp. difference protection in cooling mode
CP	Plate Heat Exchanger anti-freezing protection
PL	Radiator high temperature protection
P1	High pressure protection
P2	Low pressure protection
P3	Outdoor units current protection
P4	Compressor discharge temp. Protection
P5	Condenser high temperature protection
P6	IPM mode protection
Pb	Outdoor units anti-freezing protection
PH	High temperature protection in heating mode
HH	Tin temperature sensor malfunction
dF	Defrosting
d8	Remote control

  

Checking No.	Meanings
11	Tout temp. Value
12	Tb1 temp. Value
13	Tb2 temp. Value (Reserved)
14	T6 temp. Value (Reserved)
15	Outdoor units current
16	Power supply voltage AD value
17	EXV opening
18	Error 1
19	Error 2
20	Error 3

Temp. Sensor code	Property values
Tin/Tout/Tb1/T3/T4	B <sub>2500</sub> =4100K, R <sub>25</sub> °C=10k Ω
Tp	B <sub>2500</sub> =3950K, R <sub>25</sub> °C=5k Ω

MGC-V10W/D2N1 & MGC-V12W/D2N1

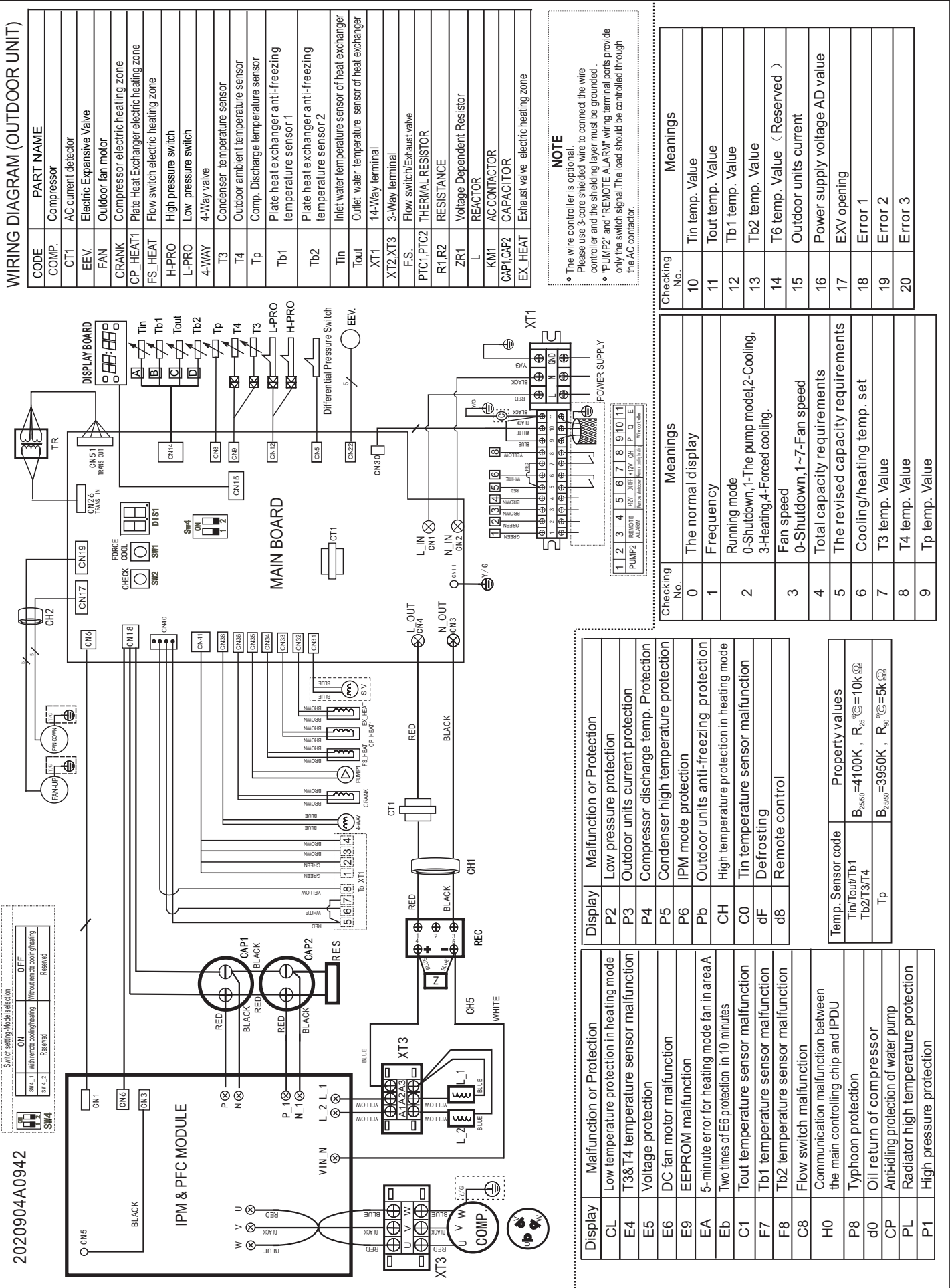

2020904A0942

Switch setting-Model selection

SW4.1	With remote cooling/heating	OFF
SW4.2	Without remote cooling/heating	Reserved

Display	Malfunction or Protection
P2	Low pressure protection
P3	Outdoor units current protection
P4	Compressor discharge temp. Protection
P5	Condenser high temperature protection
P6	IPM mode protection
Pb	Outdoor units anti-freezing protection
CH	High temperature protection in heating mode
C0	Tin temperature sensor malfunction
dF	Defrosting
d8	Remote control

Display	Malfunction or Protection
CL	Low temperature protection in heating mode
E4	T3&T4 temperature sensor malfunction
E5	Voltage protection
E6	DC fan motor malfunction
E9	EEPROM malfunction
EA	5-minute error for heating mode fan in area A
Eb	Two times of E6 protection in 10 minutes
C1	Tout temperature sensor malfunction
F7	Tb1 temperature sensor malfunction
F8	Tb2 temperature sensor malfunction
C8	Flow switch malfunction
H0	Communication malfunction between the main controlling chip and IPDU
P8	Typhoon protection
d0	Oil return of compressor
CP	Anti-idling protection of water pump
PL	Radiator high temperature protection
P1	High pressure protection

Temp. Sensor code	Property values
Tin/Tout/Tb1	$B_{25,000}=4100K, R_{25}=10k\Omega$
Tb2/T3/T4	$B_{25,000}=3950K, R_{25}=5k\Omega$



MGC-V12W/D2RN1, MGC-V14W/D2RN1 & MGC-V16W/D2RN1

WIRING DIAGRAM (OUTDOOR UNIT)

202090490066

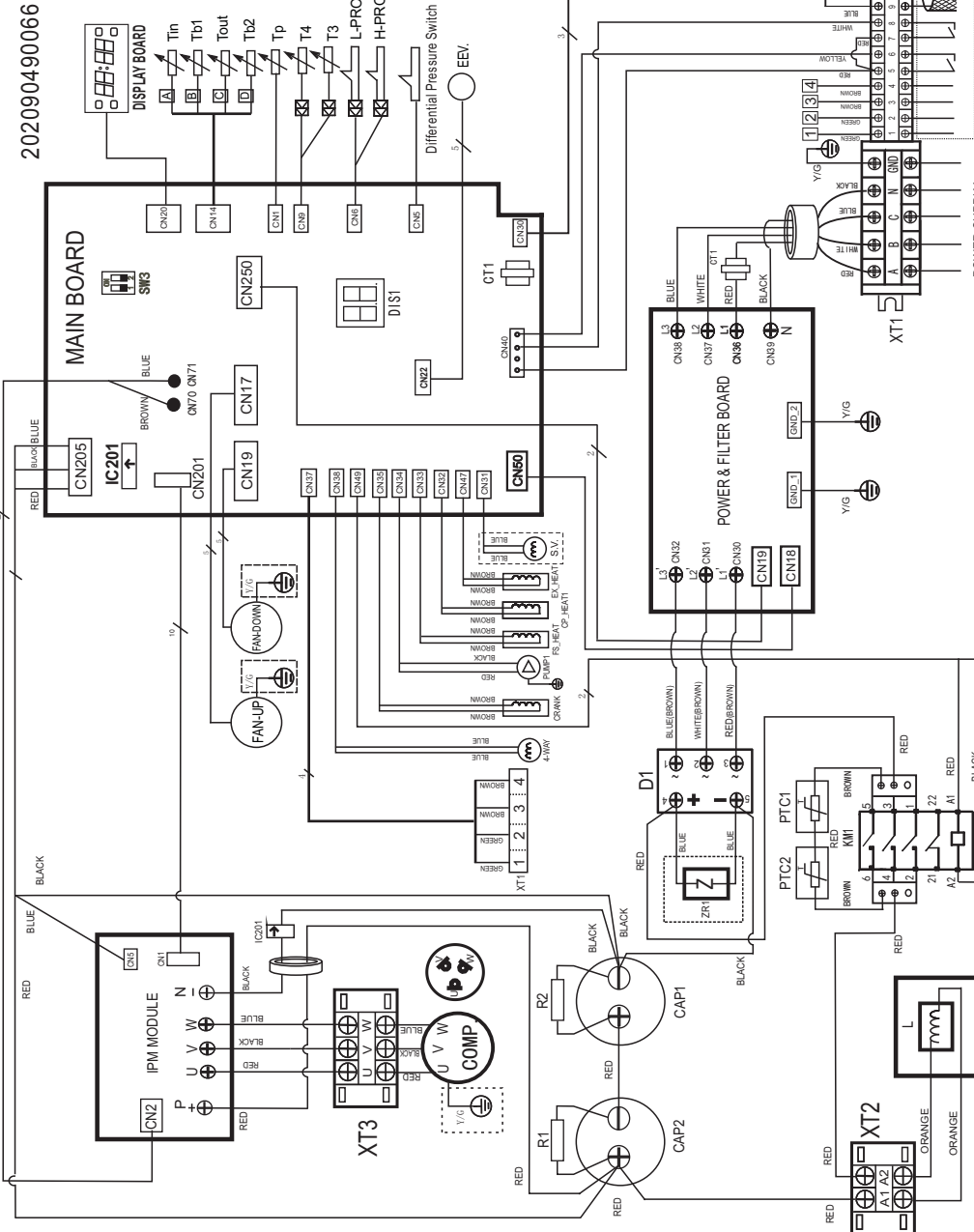

CODE	PART NAME
COMP.	Compressor
CT1	AC current detector
EEV	Electric Expansive Valve
FAN	Outdoor fan motor
CRANK	Compressor electric heating zone
CP_HEAT1	Plate Heat Exchanger electric heating zone
FS_HEAT	Flow switch electric heating zone
H-PRO	High pressure switch
L-PRO	Low pressure switch
4-WAY	4-Way valve
T3	Condenser temperature sensor
T4	Outdoor ambient temperature sensor
TP	Comp. Discharge temperature sensor
Tb1	Plate heat exchanger anti-freezing temperature sensor 1
Tb2	Plate heat exchanger anti-freezing temperature sensor 2
Tin	Inlet water temperature sensor of heat exchanger
Tout	Outlet water temperature sensor of heat exchanger
XT1	14-Way terminal
XT2	2-Way terminal
XT3	3-Way terminal
F.S.	Flow switch
PTC1,PTC2	THERMAL RESISTOR
R1,R2	RESISTANCE
ZR1	Voltage Dependent Resistor
L	REACTOR
KM1	AC CONTACTOR
CAP1,CAP2	CAPACITOR
EX_HEAT	Exhaust valve electric heating zone

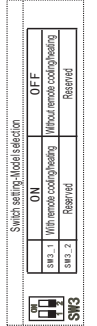

**NOTE**  
 • The wire controller is optional. Please use 3-core shielded wire to connect wire controller and the shielding layer must be grounded.  
 • PUMP2\* and REMOTE ALARM\* wiring terminal ports provide only the switch signal. The load should be controlled through the AC contactor.

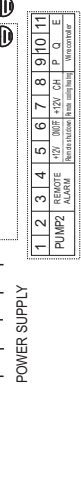

Checking No.	Meanings
0	The normal display
1	Frequency
2	Running mode
3	0-Shutdown, 1-The pump model, 2-Cooling, 3-Heating, 4-Forced cooling.
4	Fan speed
5	0-Shutdown, 1~7-Fan speed
6	Total capacity requirements
7	The revised capacity requirements
8	Cooling/heating temp. set
9	T3 temp. Value
10	Tin temp. Value
11	Tout temp. Value
12	Tb1 temp. Value
13	Tb2 temp. Value
14	T6 temp. Value (Reserved)
15	Outdoor units current
16	Power supply voltage AD value
17	EXV opening
18	Error 1
19	Error 2
20	Error 3

Display	Malfunction or Protection
PL	Radiator high temperature protection
P1	High pressure protection
P2	Low pressure protection
P3	Outdoor units current protection
P4	Compressor discharge temp. Protection
P5	Condenser high temperature protection
P6	IPM mode protection
Pb	Outdoor units anti-freezing protection
CH	High temperature protection in heating mode
C0	Tin temperature sensor malfunction
dF	Defrosting
d8	Remote control
Temp. Sensor code	Property values
Tin/Tout/Tb1/Tb2/T4	B <sub>25/55</sub> =4100K, R <sub>25</sub> °C=10k Ω
Tp	B <sub>25/55</sub> =3950K, R <sub>50</sub> °C=5k Ω

Display	Malfunction or Protection
CL	Low temperature protection in heating mode
E4	T3&T4 temperature sensor malfunction
E5	Voltage protection
E6	DC fan motor malfunction
E9	EEPROM malfunction
EA	5-minute error for heating mode fan in area A
Eb	Two times of E6 protection in 10 minutes
C1	Tout temperature sensor malfunction
F7	Tb1 temperature sensor malfunction
F8	Tb2 temperature sensor malfunction
C8	Flow switch malfunction
P8	Typhoon protection
H0	Communication malfunction between the main controlling chip and IPDU
d0	Oil return of compressor
CP	Anti-idling protection of water pump

## 9. Electric Characteristics

Model	Outdoor Unit					Power Supply			Compressor		OFM	
	Hz	Voltage	Phase	Min.	Max.	MCA	TOCA	MFA	MSC	RLA	kW	FLA
MGC-V5W/D2N1	50Hz	220~240V	1Ph	198V	264V	10.1	14.6	20	29.5	8.1	0.17	1.65
MGC-V7W/D2N1	50Hz	220~240V	1Ph	198V	264V	10.1	15.6	20	29.5	8.1	0.17	1.65
MGC-V10W/D2N1	50Hz	220~240V	1Ph	198V	264V	15.1	26.0	30	52	12.1	0.20	1.8
MGC-V12W/D2N1	50Hz	220~240V	1Ph	198V	264V	15.1	25.0	30	52	12.1	0.20	1.8
MGC-V12W/D2RN1	50Hz	380~415V	3Ph	342V	456V	8.6	8.9	15	44	6.9	0.20	1.8
MGC-V14W/D2RN1	50Hz	380~415V	3Ph	342V	456V	8.6	9.6	15	44	6.9	0.20	1.8
MGC-V16W/D2RN1	50Hz	380~415V	3Ph	342V	456V	8.6	10.1	15	44	6.9	0.20	1.8

**Remark:**

MCA: Min. Current Amps. (A)

TOCA: Total Over-current Amps. (A)

MFA: Max. Fuse Amps. (A)

MSC: Max. Starting Amps. (A)

RLA: Rated Current Amps. (A)

OFM: Outdoor Fan Motor

FLA: Full Load Amps. (A)

kW: Rated Motor Output (kW)

## 10. Capacity Tables

### MGC-V5W/D2N1

#### Cooling

Ambient temp.	Chilled water outlet temp (°C)														
	7			10			13			15			18		
	Capacity	Power	EER	Capacity	Power	EER	Capacity	Power	EER	Capacity	Power	EER	Capacity	Power	EER
(°C)	kW	kW	W/W	kW	kW	W/W	kW	kW	W/W	kW	kW	W/W	kW	kW	W/W
20	6.68	1.17	5.72	6.13	1.29	4.76	5.56	1.42	3.93	5.00	1.55	3.23	3.86	1.39	2.78
25	7.11	1.14	6.24	6.54	1.26	5.19	5.97	1.39	4.30	5.41	1.51	3.57	4.22	1.36	3.10
30	7.48	1.10	6.77	6.93	1.22	5.66	6.36	1.35	4.71	5.81	1.47	3.94	4.57	1.32	3.46
35	7.71	1.09	7.08	7.19	1.20	5.98	6.62	1.32	5.00	6.05	1.44	4.19	4.80	1.30	3.68
40	8.10	1.05	7.68	7.57	1.17	6.44	7.03	1.29	5.45	6.47	1.41	4.59	5.17	1.27	4.08
45	8.79	1.02	8.63	8.29	1.13	7.37	7.70	1.24	6.22	7.14	1.35	5.29	5.76	1.22	4.73

Note: The inlet/outlet water temperature difference is 5°C.

#### Heating

Ambient temp.	Hot water outlet temp. (°C)																	
	30			35			40			45			50			55		
	Capacity	Power	COP	Capacity	Power	COP	Capacity	Power	COP	Capacity	Power	COP	Capacity	Power	COP	Capacity	Power	COP
(°C)	kW	kW	W/W	kW	kW	W/W	kW	kW	W/W	kW	kW	W/W	kW	kW	W/W	kW	kW	W/W
-15	3.20	1.29	2.48	3.01	1.41	2.13	2.94	1.55	1.90	/	/	/	/	/	/	/	/	/
-10	3.65	1.31	2.80	3.44	1.43	2.41	3.37	1.57	2.15	/	/	/	/	/	/	/	/	/
-7	3.92	1.31	2.99	3.70	1.44	2.58	3.63	1.58	2.29	3.53	1.84	1.92	/	/	/	/	/	/
-5	4.11	1.31	3.15	3.88	1.43	2.72	3.81	1.58	2.42	3.71	1.83	2.02	/	/	/	/	/	/
-2	4.39	1.29	3.40	4.15	1.42	2.92	4.08	1.56	2.61	3.98	1.82	2.19	3.84	2.02	1.90	/	/	/
0	4.64	1.29	3.59	4.39	1.42	3.09	4.32	1.56	2.76	4.22	1.82	2.32	4.08	2.03	2.01	/	/	/
2	4.89	1.29	3.78	4.63	1.42	3.26	4.56	1.57	2.91	4.46	1.83	2.44	4.31	2.03	2.12	4.03	2.26	1.79
7	6.73	1.33	5.05	6.39	1.47	4.35	6.31	1.63	3.87	6.20	1.90	3.26	6.01	2.12	2.84	5.64	2.55	2.21
12	7.30	1.29	5.65	6.95	1.43	4.86	6.88	1.59	4.33	6.78	1.87	3.64	6.60	2.08	3.17	6.21	2.32	2.67
15	7.89	1.27	6.19	7.53	1.42	5.31	7.47	1.58	4.72	7.37	1.86	3.97	7.19	2.08	3.46	6.78	2.32	2.92
20	8.97	1.25	7.20	8.58	1.39	6.18	8.54	1.56	5.49	8.45	1.84	4.60	8.03	2.06	3.89	7.60	2.30	3.30

Note: The inlet/outlet water temperature difference is 5°C.

**MGC-V7W/D2N1****Cooling**

Ambient temp. (°C)	Chilled water outlet temp (°C)														
	7			10			13			15			18		
	Capacity	Power	EER	Capacity	Power	EER	Capacity	Power	EER	Capacity	Power	EER	Capacity	Power	EER
(°C)	kW	kW	W/W	kW	kW	W/W	kW	kW	W/W	kW	kW	W/W	kW	kW	W/W
20	9.69	2.09	4.64	8.84	2.13	4.14	7.93	2.18	3.63	7.00	2.25	3.11	4.52	1.75	2.58
25	10.48	2.05	5.11	9.57	2.08	4.60	8.59	2.13	4.03	7.60	2.19	3.47	5.08	1.71	2.96
30	11.31	2.00	5.66	10.35	2.02	5.11	9.27	2.07	4.47	8.21	2.13	3.85	5.69	1.69	3.37
35	11.87	1.97	6.04	10.87	1.99	5.46	9.74	2.03	4.79	8.63	2.09	4.13	6.12	1.66	3.68
40	12.78	1.92	6.67	11.41	1.94	5.88	10.51	1.97	5.32	9.30	2.03	4.57	6.82	1.63	4.18
45	14.12	1.86	7.60	12.98	1.87	6.96	11.61	1.90	6.11	10.28	1.95	5.28	7.88	1.59	4.96

Note: The inlet/outlet water temperature difference is 5°C.

**Heating**

Ambient temp. (°C)	Hot water outlet temp. (°C)																	
	30			35			40			45			50			55		
	Capacity	Power	COP	Capacity	Power	COP	Capacity	Power	COP	Capacity	Power	COP	Capacity	Power	COP	Capacity	Power	COP
(°C)	kW	kW	W/W	kW	kW	W/W	kW	kW	W/W	kW	kW	W/W	kW	kW	W/W	kW	kW	W/W
-15	4.13	1.70	2.43	3.88	1.86	2.09	3.80	2.04	1.86	/	/	/	/	/	/	/	/	/
-10	4.71	1.72	2.74	4.44	1.88	2.37	4.35	2.07	2.10	/	/	/	/	/	/	/	/	/
-7	5.06	1.73	2.93	4.78	1.89	2.53	4.68	2.08	2.25	4.56	2.42	1.88	/	/	/	/	/	/
-5	5.30	1.72	3.09	5.01	1.88	2.66	4.91	2.07	2.37	4.79	2.41	1.98	/	/	/	/	/	/
-2	5.67	1.70	3.33	5.35	1.87	2.87	5.26	2.05	2.56	5.14	2.39	2.15	4.95	2.66	1.86	/	/	/
0	5.99	1.70	3.52	5.66	1.87	3.03	5.57	2.06	2.71	5.45	2.40	2.27	5.26	2.67	1.97	/	/	/
2	6.31	1.70	3.71	5.97	1.87	3.20	5.88	2.06	2.85	5.76	2.40	2.40	5.56	2.67	2.08	5.20	2.97	1.75
7	8.68	1.75	4.96	8.24	1.93	4.26	8.14	2.15	3.79	8.00	2.50	3.20	7.75	2.79	2.78	7.27	3.35	2.17
12	9.42	1.70	5.54	8.96	1.88	4.77	8.88	2.09	4.25	8.75	2.45	3.56	8.52	2.74	3.11	8.01	3.06	2.62
15	10.19	1.68	6.07	9.71	1.87	5.21	9.64	2.08	4.62	9.52	2.45	3.89	9.27	2.73	3.39	8.75	3.05	2.87
20	11.58	1.64	7.06	11.07	1.83	6.06	11.02	2.05	5.38	10.91	2.42	4.51	10.36	2.71	3.82	9.80	3.03	3.24

Note: The inlet/outlet water temperature difference is 5°C.

**MGC-V10W/D2N1****Cooling**

Ambient temp.	Chilled water outlet temp (°C)														
	7			10			13			15			18		
	Capacity	Power	EER	Capacity	Power	EER	Capacity	Power	EER	Capacity	Power	EER	Capacity	Power	EER
(°C)	kW	kW	W/W	kW	kW	W/W	kW	kW	W/W	kW	kW	W/W	kW	kW	W/W
20	11.08	2.23	4.97	10.99	2.45	4.49	10.62	2.68	3.97	10.00	2.95	3.39	9.16	3.25	2.82
25	11.77	2.25	5.22	11.66	2.47	4.72	11.27	2.72	4.15	10.61	2.99	3.55	9.73	3.29	2.95
30	12.93	2.28	5.67	12.81	2.50	5.12	12.38	2.75	4.50	11.66	3.03	3.85	10.70	3.33	3.21
35	13.74	2.29	5.99	13.61	2.52	5.40	13.15	2.77	4.74	12.39	3.05	4.06	11.37	3.37	3.38
40	15.17	2.32	6.54	14.66	2.55	5.75	13.87	2.81	4.94	12.85	3.09	4.15	11.61	3.41	3.40
45	16.92	2.35	7.20	16.36	2.59	6.32	15.49	2.85	5.43	14.36	3.15	4.56	13.00	3.48	3.74

Note: The inlet/outlet water temperature difference is 5°C.

**Heating**

Ambient temp.	Hot water outlet temp. (°C)																	
	30			35			40			45			50			55		
	Capacity	Power	COP	Capacity	Power	COP	Capacity	Power	COP	Capacity	Power	COP	Capacity	Power	COP	Capacity	Power	COP
(°C)	kW	kW	W/W	kW	kW	W/W	kW	kW	W/W	kW	kW	W/W	kW	kW	W/W	kW	kW	W/W
-15	5.68	2.13	2.66	5.33	2.33	2.29	5.22	2.56	2.04	/	/	/	/	/	/	/	/	/
-10	6.48	2.16	3.00	6.10	2.36	2.59	5.98	2.60	2.30	/	/	/	/	/	/	/	/	/
-7	6.96	2.17	3.20	6.57	2.37	2.77	6.44	2.62	2.46	6.26	3.05	2.06	/	/	/	/	/	/
-5	7.29	2.16	3.38	6.88	2.36	2.92	6.76	2.60	2.60	6.58	3.03	2.17	/	/	/	/	/	/
-2	7.79	2.13	3.65	7.36	2.34	3.14	7.24	2.58	2.80	7.06	3.01	2.35	6.81	3.34	2.04	/	/	/
0	8.23	2.13	3.86	7.78	2.34	3.32	7.66	2.59	2.96	7.49	3.01	2.49	7.23	3.35	2.16	/	/	/
2	8.67	2.13	4.06	8.21	2.34	3.50	8.09	2.59	3.12	7.91	3.02	2.62	7.65	3.36	2.28	7.14	3.73	1.92
7	11.94	2.20	5.43	11.33	2.43	4.67	11.19	2.69	4.15	11.00	3.14	3.50	10.66	3.50	3.04	10.00	4.21	2.37
12	12.95	2.13	6.07	12.33	2.36	5.22	12.21	2.63	4.65	12.03	3.08	3.90	11.71	3.44	3.40	11.02	3.84	2.87
15	14.01	2.11	6.65	13.36	2.34	5.70	13.26	2.62	5.06	13.08	3.07	4.26	12.75	3.43	3.71	12.03	3.83	3.14
20	15.92	2.06	7.73	15.22	2.30	6.63	15.15	2.57	5.89	15.00	3.04	4.94	14.24	3.41	4.18	13.48	3.80	3.54

Note: The inlet/outlet water temperature difference is 5°C.

**MGC-V12W/D2N1****Cooling**

Ambient temp.	Chilled water outlet temp. (°C)														
	7			10			13			15			18		
	Capacity	Power	EER	Capacity	Power	EER	Capacity	Power	EER	Capacity	Power	EER	Capacity	Power	EER
(°C)	kW	kW	W/W	kW	kW	W/W	kW	kW	W/W	kW	kW	W/W	kW	kW	W/W
20	12.41	2.65	4.69	12.31	2.90	4.24	11.89	3.18	3.74	11.20	3.50	3.20	10.26	3.85	2.66
25	13.18	2.67	4.93	13.06	2.93	4.46	12.62	3.22	3.91	11.88	3.55	3.35	10.90	3.91	2.79
30	14.48	2.70	5.36	14.35	2.97	4.83	13.87	3.26	4.25	13.06	3.59	3.63	11.98	3.96	3.03
35	15.39	2.72	5.65	15.24	2.99	5.10	14.73	3.29	4.47	13.88	3.62	3.83	12.73	3.99	3.19
40	16.99	2.75	6.18	16.42	3.03	5.43	15.53	3.33	4.67	14.39	3.67	3.92	13.00	4.05	3.21
45	18.95	2.79	6.80	18.32	3.07	5.96	17.35	3.39	5.12	16.08	3.74	4.30	14.56	4.13	3.53

Note: The inlet/outlet water temperature difference is 5°C.

**Heating**

Ambient temp.	Hot water outlet temp. (°C)																	
	30			35			40			45			50			55		
	Capacity	Power	COP	Capacity	Power	COP	Capacity	Power	COP	Capacity	Power	COP	Capacity	Power	COP	Capacity	Power	COP
(°C)	kW	kW	W/W	kW	kW	W/W	kW	kW	W/W	kW	kW	W/W	kW	kW	W/W	kW	kW	W/W
-15	6.35	2.57	2.47	5.96	2.81	2.12	5.84	3.08	1.89	/	/	/	/	/	/	/	/	/
-10	7.25	2.60	2.79	6.83	2.84	2.41	6.69	3.13	2.14	/	/	/	/	/	/	/	/	/
-7	7.79	2.62	2.98	7.34	2.85	2.57	7.20	3.15	2.28	7.00	3.67	1.91	/	/	/	/	/	/
-5	8.16	2.60	3.14	7.70	2.84	2.71	7.55	3.13	2.41	7.36	3.65	2.02	/	/	/	/	/	/
-2	8.71	2.57	3.39	8.23	2.82	2.92	8.09	3.11	2.60	7.90	3.62	2.18	7.62	4.02	1.89	/	/	/
0	9.21	2.57	3.58	8.70	2.82	3.08	8.57	3.11	2.75	8.37	3.63	2.31	8.08	4.03	2.01	/	/	/
2	9.70	2.57	3.77	9.18	2.82	3.25	9.04	3.12	2.90	8.85	3.63	2.44	8.55	4.04	2.12	7.99	4.49	1.78
7	13.35	2.65	5.04	12.67	2.92	4.34	12.51	3.24	3.86	12.30	3.78	3.25	11.92	4.21	2.83	11.18	5.07	2.20
12	14.48	2.57	5.64	13.78	2.84	4.85	13.66	3.16	4.32	13.45	3.71	3.63	13.09	4.15	3.16	12.32	4.63	2.66
15	15.66	2.54	6.18	14.94	2.82	5.30	14.82	3.15	4.70	14.63	3.70	3.95	14.26	4.13	3.45	13.45	4.61	2.92
20	17.80	2.48	7.18	17.02	2.76	6.16	16.94	3.09	5.47	16.77	3.65	4.59	15.92	4.10	3.88	15.07	4.58	3.29

Note: The inlet/outlet water temperature difference is 5°C.

**MGC-V12W/D2RN1****Cooling**

Ambient temp.	Chilled water outlet temp. (°C)														
	7			10			13			15			18		
	Capacity	Power	EER	Capacity	Power	EER	Capacity	Power	EER	Capacity	Power	EER	Capacity	Power	EER
(°C)	kW	kW	W/W	kW	kW	W/W	kW	kW	W/W	kW	kW	W/W	kW	kW	W/W
20	12.41	2.56	4.86	12.31	2.80	4.39	11.89	3.07	3.88	11.20	3.38	3.31	10.26	3.72	2.76
25	13.18	2.58	5.10	13.06	2.83	4.61	12.62	3.11	4.05	11.88	3.43	3.47	10.90	3.77	2.89
30	14.48	2.61	5.55	14.35	2.87	5.00	13.87	3.15	4.40	13.06	3.47	3.76	11.98	3.82	3.14
35	15.39	2.63	5.85	15.24	2.89	5.28	14.73	3.18	4.63	13.88	3.50	3.97	12.73	3.86	3.30
40	16.99	2.66	6.40	16.42	2.92	5.62	15.53	3.22	4.83	14.39	3.54	4.06	13.00	3.91	3.32
45	18.95	2.69	7.04	18.32	2.97	6.17	17.35	3.27	5.31	16.08	3.61	4.46	14.56	3.98	3.65

Note: The inlet/outlet water temperature difference is 5°C.

**Heating**

Ambient temp.	Hot water outlet temp. (°C)																	
	30			35			40			45			50			55		
	Capacity	Power	COP	Capacity	Power	COP	Capacity	Power	COP	Capacity	Power	COP	Capacity	Power	COP	Capacity	Power	COP
(°C)	kW	kW	W/W	kW	kW	W/W	kW	kW	W/W	kW	kW	W/W	kW	kW	W/W	kW	kW	W/W
-15	6.35	2.53	2.51	5.96	2.76	2.16	5.84	3.03	1.92	/	/	/	/	/	/	/	/	/
-10	7.25	2.56	2.83	6.83	2.79	2.44	6.69	3.08	2.17	/	/	/	/	/	/	/	/	/
-7	7.79	2.57	3.02	7.34	2.81	2.61	7.20	3.10	2.32	7.00	3.61	1.94	/	/	/	/	/	/
-5	8.16	2.56	3.19	7.70	2.80	2.75	7.55	3.08	2.45	7.36	3.59	2.05	/	/	/	/	/	/
-2	8.71	2.53	3.45	8.23	2.78	2.96	8.09	3.06	2.65	7.90	3.56	2.22	7.62	3.96	1.93	/	/	/
0	9.21	2.53	3.64	8.70	2.78	3.13	8.57	3.06	2.80	8.37	3.57	2.35	8.08	3.97	2.04	/	/	/
2	9.70	2.53	3.83	9.18	2.78	3.31	9.04	3.07	2.95	8.85	3.57	2.48	8.55	3.98	2.15	7.99	4.42	1.81
7	13.35	2.61	5.12	12.67	2.88	4.40	12.51	3.19	3.92	12.30	3.72	3.31	11.92	4.15	2.87	11.18	4.99	2.24
12	14.48	2.53	5.73	13.78	2.80	4.93	13.66	3.11	4.39	13.45	3.65	3.68	13.09	4.08	3.21	12.32	4.55	2.71
15	15.66	2.49	6.28	14.94	2.78	5.38	14.82	3.10	4.78	14.63	3.64	4.02	14.26	4.07	3.50	13.45	4.54	2.96
20	17.80	2.44	7.30	17.02	2.72	6.26	16.94	3.05	5.56	16.77	3.60	4.66	15.92	4.03	3.95	15.07	4.51	3.34

Note: The inlet/outlet water temperature difference is 5°C.

**MGC-V14W/D2RN1****Cooling**

Ambient temp.	Chilled water outlet temp. (°C)														
	7			10			13			15			18		
	Capacity	Power	EER	Capacity	Power	EER	Capacity	Power	EER	Capacity	Power	EER	Capacity	Power	EER
(°C)	kW	kW	W/W	kW	kW	W/W	kW	kW	W/W	kW	kW	W/W	kW	kW	W/W
20	13.87	2.97	4.66	13.75	3.24	4.24	13.29	3.55	3.75	12.50	3.90	3.21	11.08	3.74	2.96
25	14.92	3.02	4.94	14.79	3.29	4.49	14.28	3.61	3.96	13.43	3.97	3.39	11.92	3.81	3.13
30	16.38	3.07	5.34	16.23	3.35	4.84	15.68	3.68	4.27	14.75	4.04	3.65	13.09	3.87	3.38
35	17.39	3.10	5.60	17.23	3.39	5.08	16.64	3.72	4.47	15.66	4.08	3.84	13.91	3.91	3.55
40	18.92	3.15	6.00	18.28	3.45	5.30	17.29	3.78	4.57	15.99	4.15	3.85	13.99	3.98	3.52
45	21.07	3.23	6.53	20.37	3.53	5.77	19.28	3.88	4.97	17.85	4.25	4.20	15.65	4.07	3.84

Note: The inlet/outlet water temperature difference is 5°C.

**Heating**

Ambient temp.	Hot water outlet temp. (°C)																	
	30			35			40			45			50			55		
	Capacity	Power	COP	Capacity	Power	COP	Capacity	Power	COP	Capacity	Power	COP	Capacity	Power	COP	Capacity	Power	COP
(°C)	kW	kW	W/W	kW	kW	W/W	kW	kW	W/W	kW	kW	W/W	kW	kW	W/W	kW	kW	W/W
-15	7.43	3.02	2.46	7.16	3.28	2.18	6.92	3.59	1.93	/	/	/	/	/	/	/	/	/
-10	8.43	3.06	2.75	8.10	3.34	2.43	7.79	3.65	2.13	/	/	/	/	/	/	/	/	/
-7	9.03	3.09	2.92	8.67	3.37	2.57	8.31	3.69	2.25	8.13	4.01	2.03	/	/	/	/	/	/
-5	9.26	3.02	3.06	8.88	3.30	2.70	8.52	3.61	2.36	8.33	3.92	2.12	/	/	/	/	/	/
-2	9.60	2.92	3.28	9.21	3.19	2.89	8.83	3.50	2.53	8.62	3.80	2.27	8.48	4.20	2.02	/	/	/
0	10.13	2.93	3.46	9.72	3.20	3.04	9.32	3.51	2.66	9.10	3.82	2.38	8.95	4.21	2.13	/	/	/
2	10.67	2.93	3.64	10.24	3.21	3.19	9.81	3.52	2.79	9.58	3.84	2.50	9.43	4.23	2.23	8.99	4.66	1.93
7	15.37	3.23	4.76	14.75	3.50	4.22	14.14	3.90	3.63	13.80	4.25	3.25	13.58	4.70	2.89	12.96	5.19	2.50
12	16.27	3.13	5.19	15.63	3.44	4.54	14.99	3.79	3.95	14.65	4.13	3.55	14.43	4.58	3.15	13.77	5.07	2.72
15	17.62	3.11	5.66	16.95	3.43	4.94	16.28	3.79	4.29	15.91	4.14	3.84	15.68	4.58	3.42	14.97	5.07	2.95
20	20.11	3.08	6.53	19.36	3.40	5.69	18.61	3.77	4.93	18.22	4.12	4.42	17.47	4.58	3.81	16.70	5.08	3.29

Note: The inlet/outlet water temperature difference is 5°C.



**MGC-V16W/D2RN1****Cooling**

Ambient temp.	Chilled water outlet temp. (°C)														
	7			10			13			15			18		
	Capacity	Power	EER	Capacity	Power	EER	Capacity	Power	EER	Capacity	Power	EER	Capacity	Power	EER
(°C)	kW	kW	W/W	kW	kW	W/W	kW	kW	W/W	kW	kW	W/W	kW	kW	W/W
20	16.07	3.46	4.64	15.98	3.78	4.23	15.44	4.13	3.74	14.50	4.53	3.20	12.81	4.32	2.96
25	17.32	3.53	4.91	17.19	3.86	4.45	16.59	4.22	3.93	15.57	4.61	3.38	13.76	4.40	3.13
30	19.03	3.61	5.27	18.87	3.94	4.80	18.21	4.30	4.23	17.09	4.71	3.63	15.10	4.48	3.37
35	20.21	3.66	5.52	20.02	3.99	5.02	19.33	4.36	4.43	18.14	4.77	3.81	16.04	4.54	3.53
40	21.99	3.74	5.89	21.25	4.07	5.22	20.08	4.45	4.52	18.52	4.86	3.81	16.13	4.62	3.49
45	24.51	3.84	6.38	23.68	4.19	5.65	22.37	4.57	4.90	20.65	4.98	4.15	18.02	4.74	3.80

Note: The inlet/outlet water temperature difference is 5°C.

**Heating**

Ambient temp.	Hot water outlet temp. (°C)																	
	30			35			40			45			50			55		
	Capacity	Power	COP	Capacity	Power	COP	Capacity	Power	COP	Capacity	Power	COP	Capacity	Power	COP	Capacity	Power	COP
(°C)	kW	kW	W/W	kW	kW	W/W	kW	kW	W/W	kW	kW	W/W	kW	kW	W/W	kW	kW	W/W
-15	8.29	3.43	2.42	8.08	3.73	2.17	7.89	4.08	1.94	/	/	/	/	/	/	/	/	/
-10	9.38	3.49	2.69	9.11	3.79	2.40	8.84	4.15	2.13	/	/	/	/	/	/	/	/	/
-7	10.04	3.52	2.85	9.72	3.83	2.54	9.41	4.20	2.24	9.24	4.56	2.03	/	/	/	/	/	/
-5	10.26	3.42	3.00	9.92	3.73	2.66	9.60	4.09	2.35	9.41	4.44	2.12	/	/	/	/	/	/
-2	10.58	3.27	3.23	10.22	3.57	2.86	9.87	3.91	2.52	9.66	4.25	2.27	9.31	4.69	1.99	/	/	/
0	11.18	3.28	3.40	10.79	3.56	3.03	10.41	3.93	2.65	10.18	4.27	2.38	9.80	4.71	2.08	/	/	/
2	11.77	3.30	3.57	11.36	3.54	3.21	10.95	3.94	2.78	10.71	4.29	2.49	10.29	4.73	2.18	9.89	5.22	1.89
7	17.61	3.71	4.75	17.00	4.00	4.25	16.38	4.46	3.67	16.00	4.85	3.30	15.37	5.35	2.87	14.75	5.90	2.50
12	18.37	3.60	5.10	17.73	3.95	4.48	17.08	4.35	3.93	16.69	4.74	3.52	16.03	5.22	3.07	15.37	5.77	2.67
15	19.92	3.60	5.53	19.23	3.95	4.86	18.54	4.35	4.27	18.11	4.75	3.82	17.40	5.24	3.32	16.69	5.79	2.88
20	22.76	3.59	6.33	21.99	3.94	5.58	21.23	4.35	4.88	20.75	4.75	4.37	19.94	5.25	3.80	19.13	5.80	3.30

Note: The inlet/outlet water temperature difference is 5°C.

### 11. Operation Limits

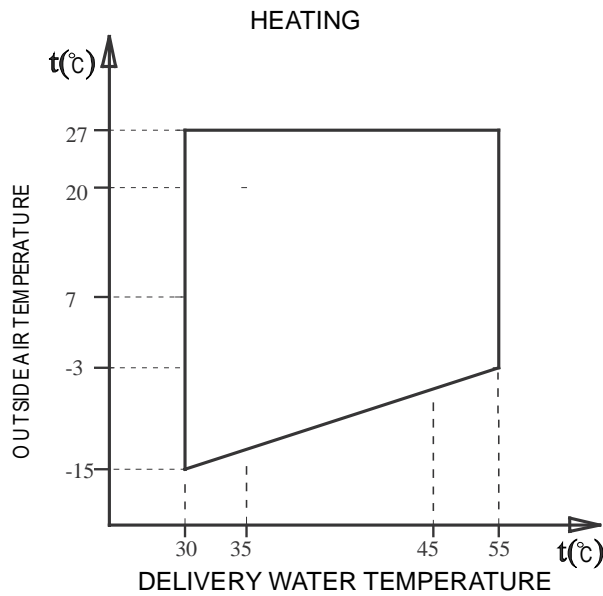
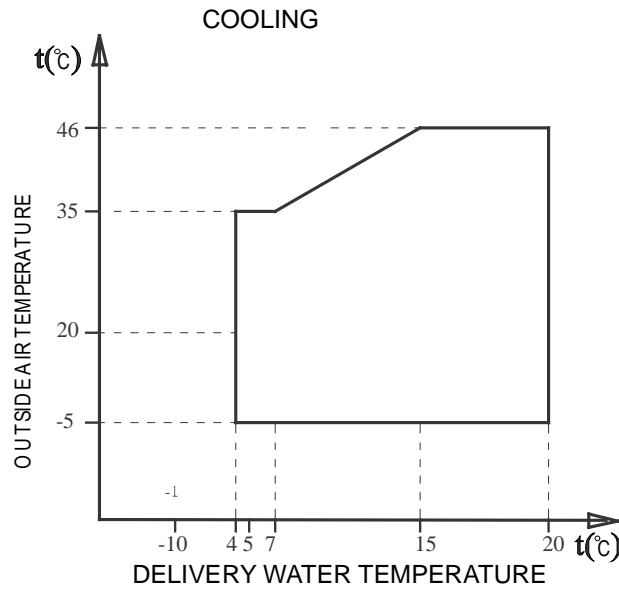

#### 11.1 Ethylene Glycol Solutions

Water and ethylene glycol solutions used as a thermal vector in the place of water reduce the performance of the unit. Multiply the performance figures by the values given in the following table.

Freezing point (°C)						
	0	-5	-10	-15	-20	-25
Percentage of ethylene glycol in weight						
	0	12%	20%	28%	35%	40%
<b>cPf</b>	1	0.98	0.97	0.965	0.96	0.955
<b>cQ</b>	1	1.02	1.04	1.075	1.11	1.14
<b>cdp</b>	1	1.07	1.11	1.18	1.22	1.24

**cPf**: Correction factor of heating/cooling capacity drop

**cQ**: Correction factor of flow rate

**cdp**: Correction factor of pressure drop

**Note:**

1. During winter leaving the unit unused, please drain water out completely from unit if no anti-freeze were charged into pipeline, or keep power on (at standby or off status) and ensure that water is contained inside of unit.
2. When ambient temperature low than 5°C, running cooling mode must be charged antifreeze. Refer to the upper table for the charged volume.

**11.2 Fouling Factors**

The performance data given refer to conditions with clean evaporator plates (fouling factor=1). For different fouling factors, multiply the figures in the performance tables by the coefficient given in the following table.

Fouling factors (m <sup>2</sup> °C/W)	Evaporator		
	f1	fk1	fx1
4.4×10 <sup>-5</sup>	-	-	-
0.86×10 <sup>-4</sup>	0.96	0.99	0.99
1.72×10 <sup>-4</sup>	0.93	0.98	0.98

**f1:** Correction factor of capacity

**fk1:** Power input correction factor of compressor

**fx1:** Correction factor of total power input

## 12. Hydraulic Data

### 12.1 Useful pump head curves

$\Delta P$ -C (constant) curve for 5/7 kW

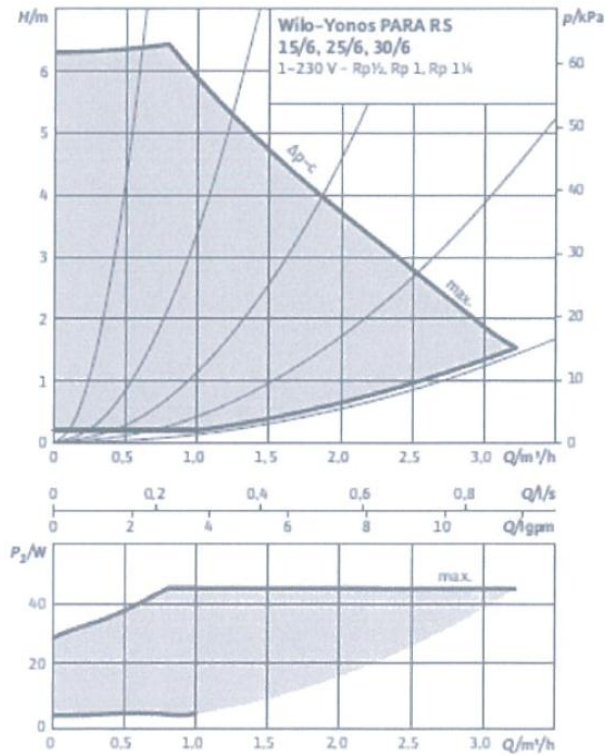

$\Delta P$ -C(constant) curve for 10/12/14/16 kW

Constant speed I, II, III

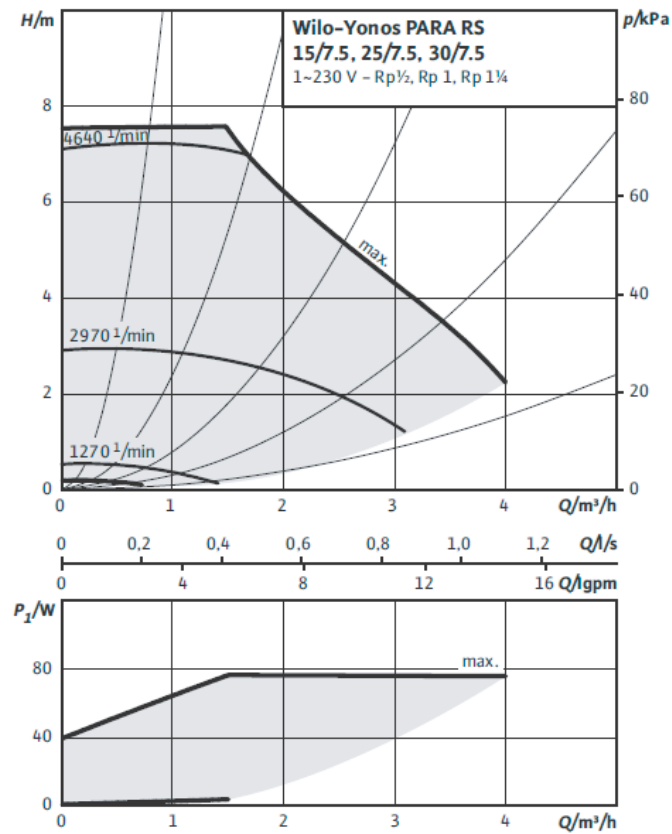

## 12.2 Water Side Water Pressure Drop

### MGC-V5W/D2N1, MGC-V7W/D2N1

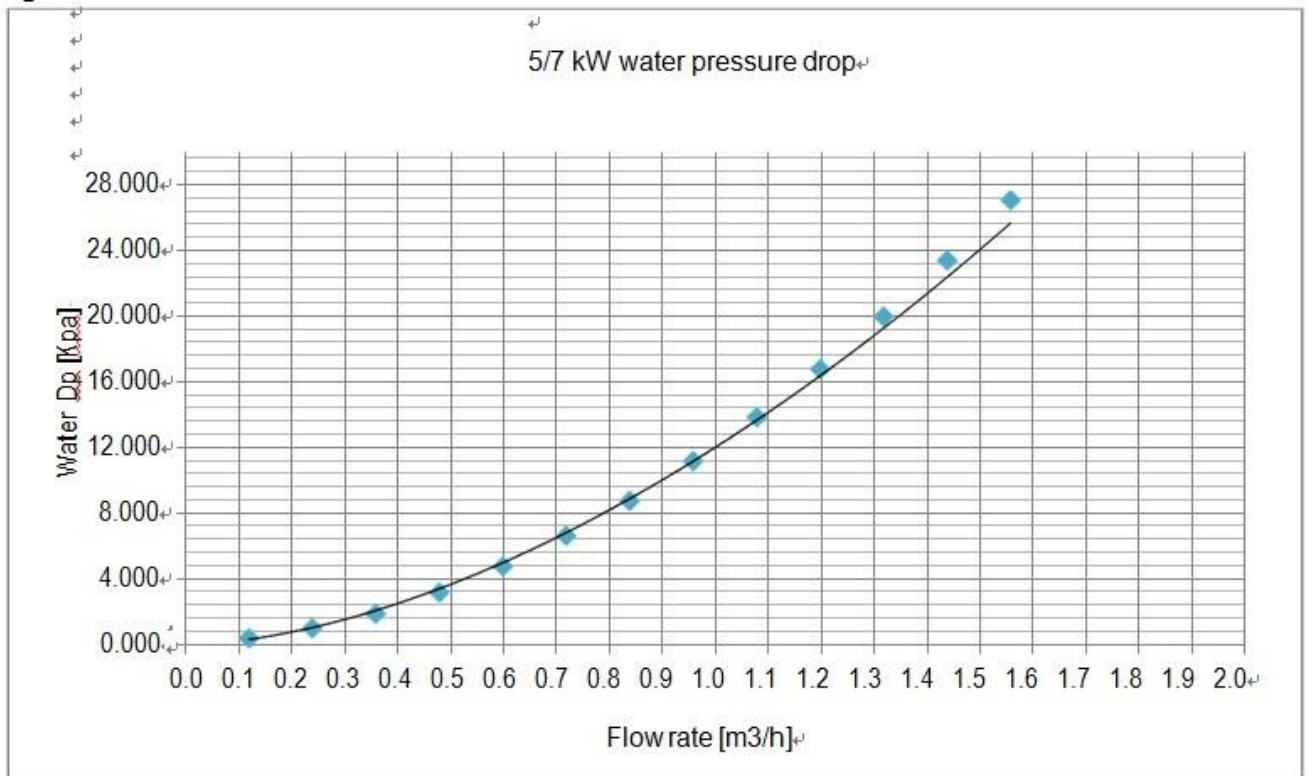

### MGC-V10W/D2N1

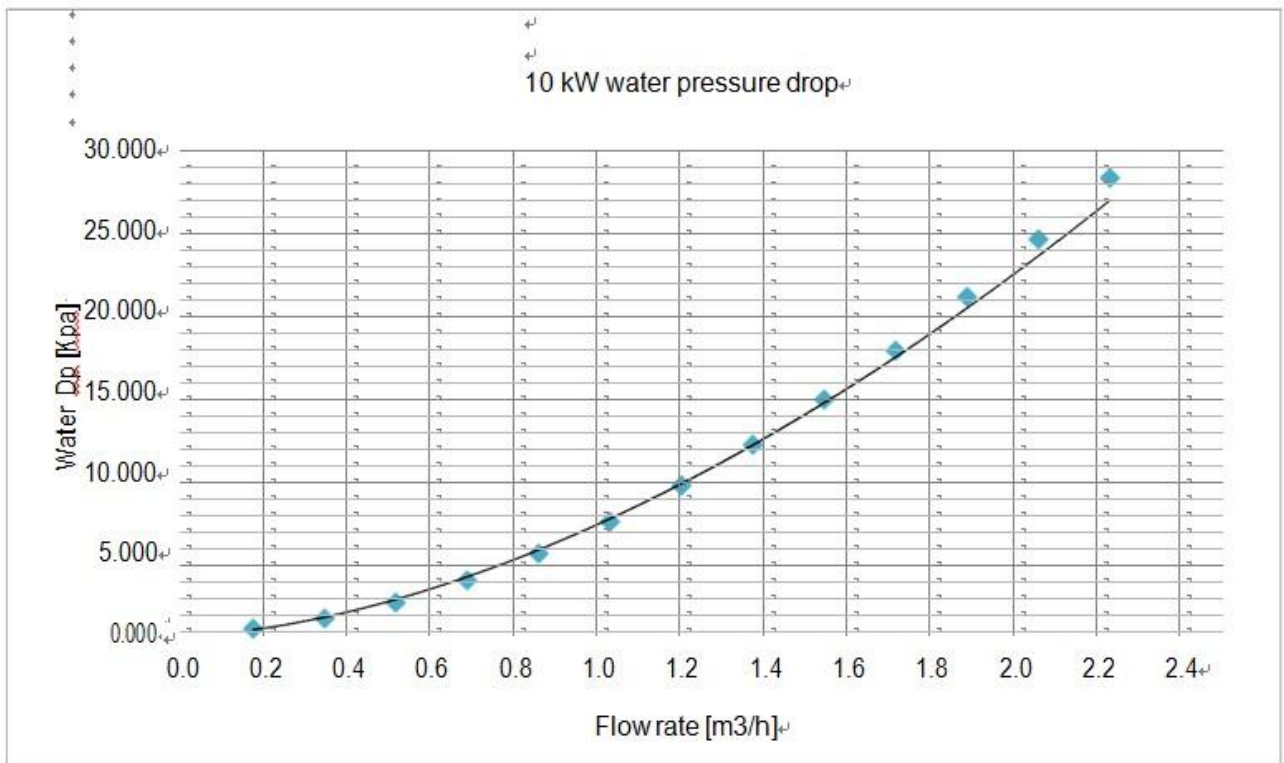

**MGC-V12W/D2N1, MGC-V12W/D2RN1**

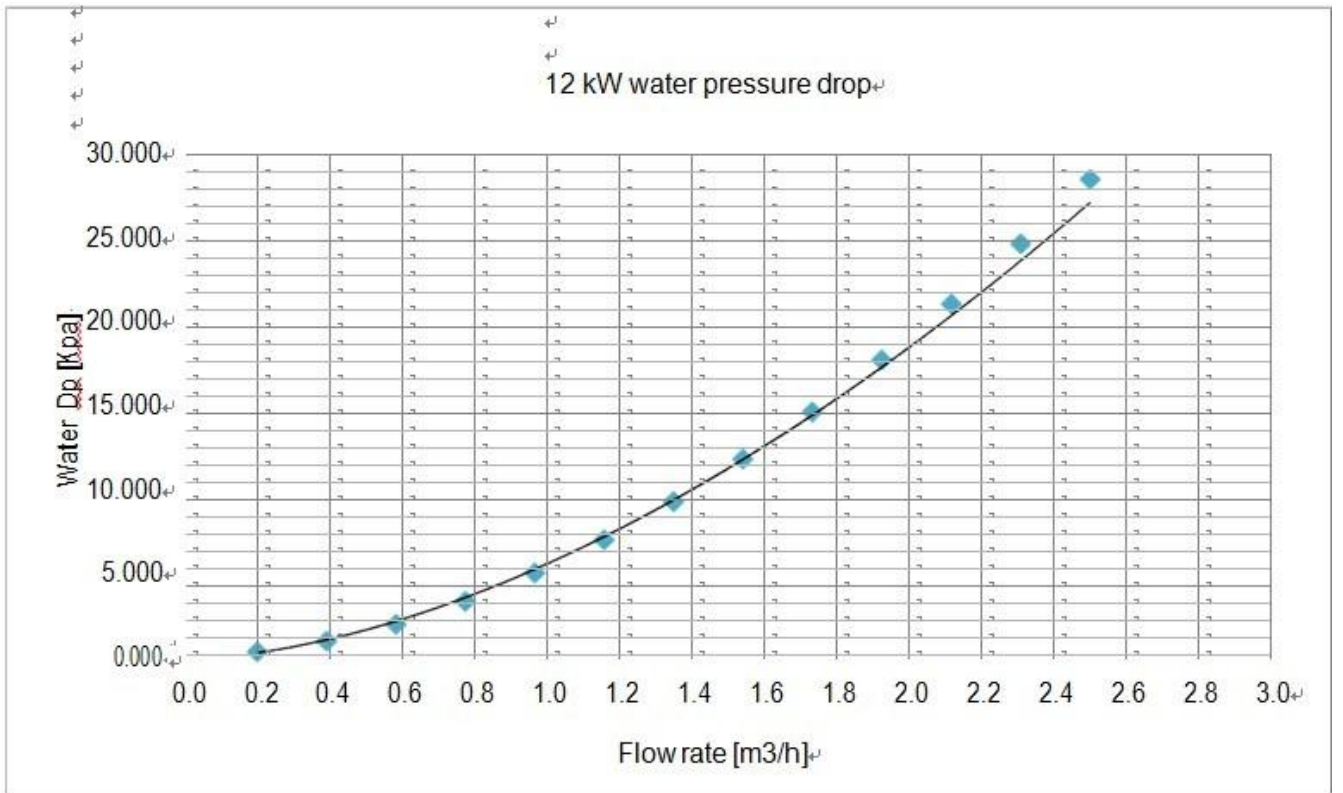

**MGC-V14W/D2RN1**

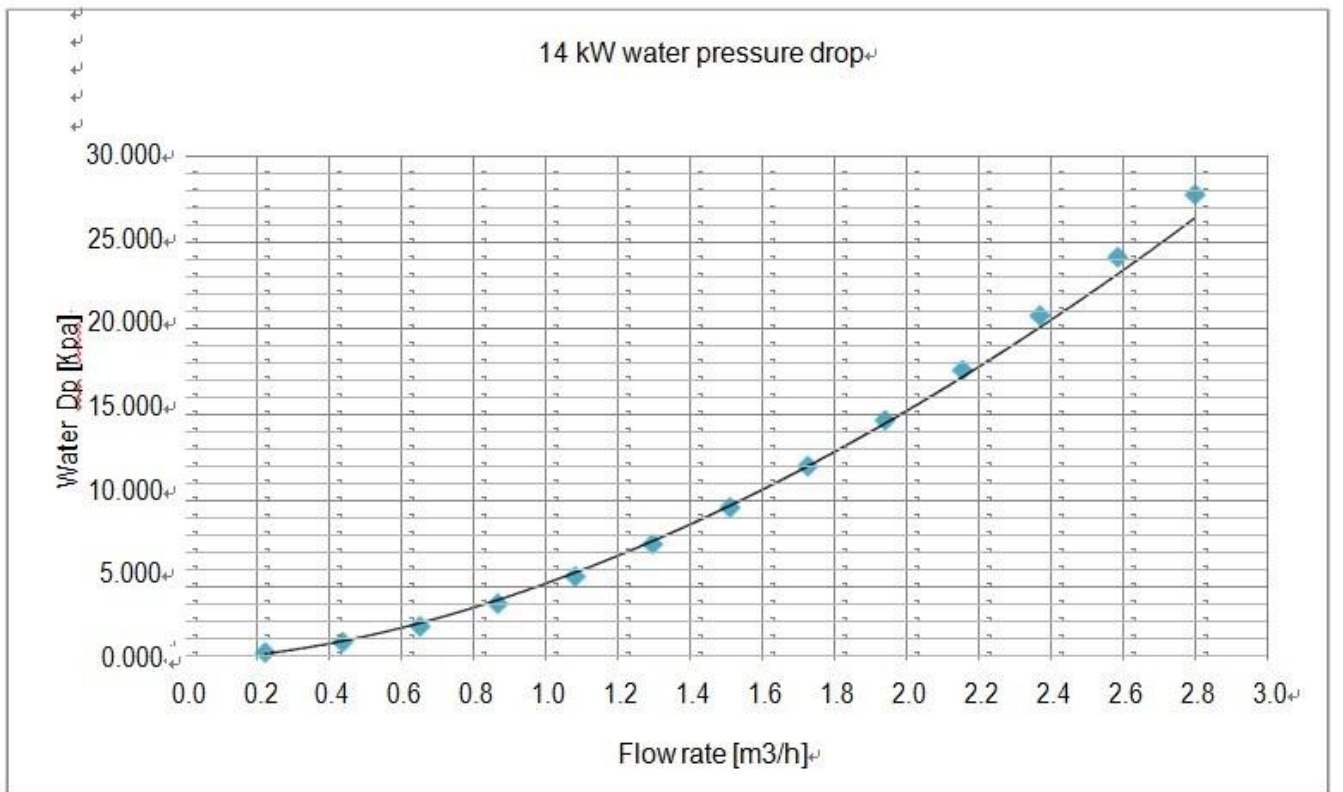

**MGC-V16W/D2RN1**

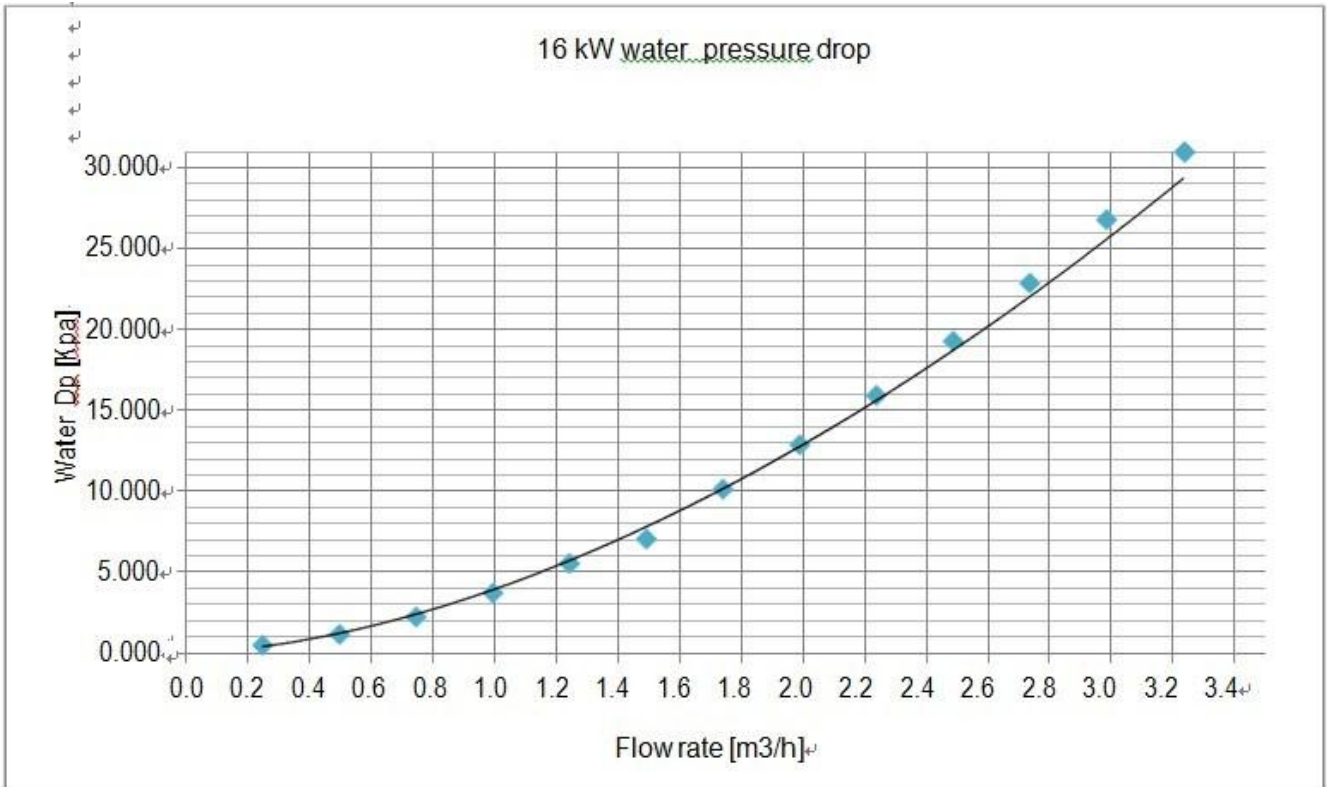

### 13. Sound Level

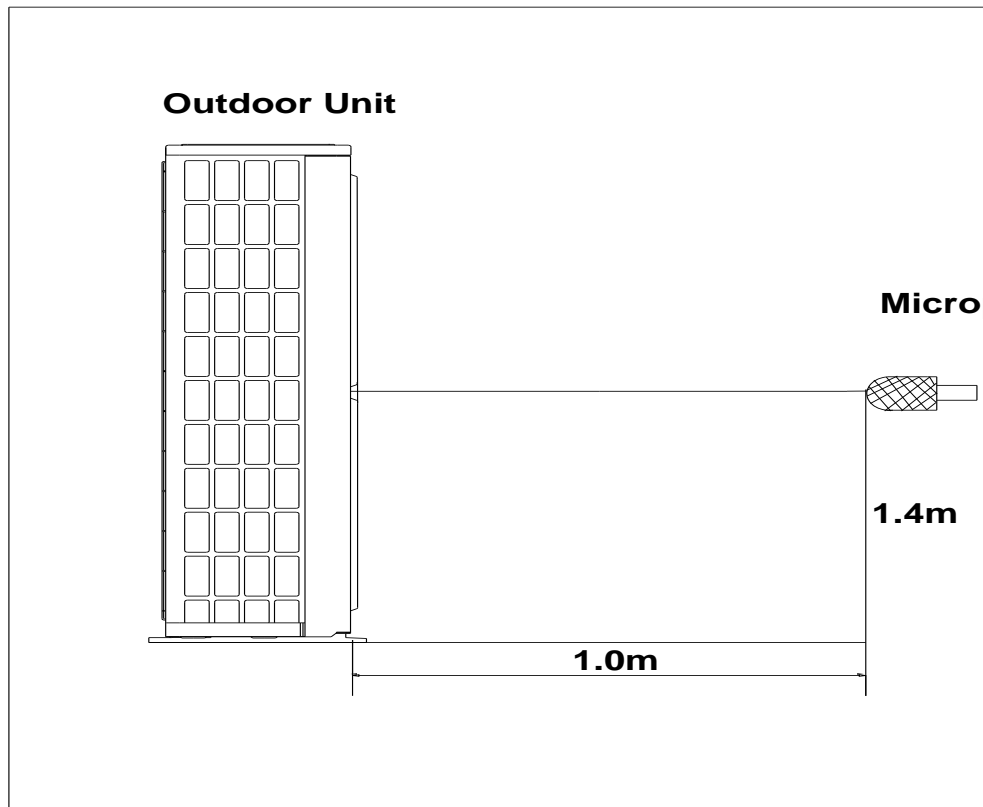

Model	Noise level (dB(A))
MGC-V5W/D2N1	58
MGC-V7W/D2N1	58
MGC-V10W/D2N1	59
MGC-V12W/D2N1	59
MGC-V12W/D2RN1	59
MGC-V14W/D2RN1	60
MGC-V16W/D2RN1	60

**Note:**

It is tested 1 meter away from the machine in a semi-anechoic room (sound pressure).



### 14. Exploded View

MGC-V5W/D2N1, MGC-V7W/D2N1

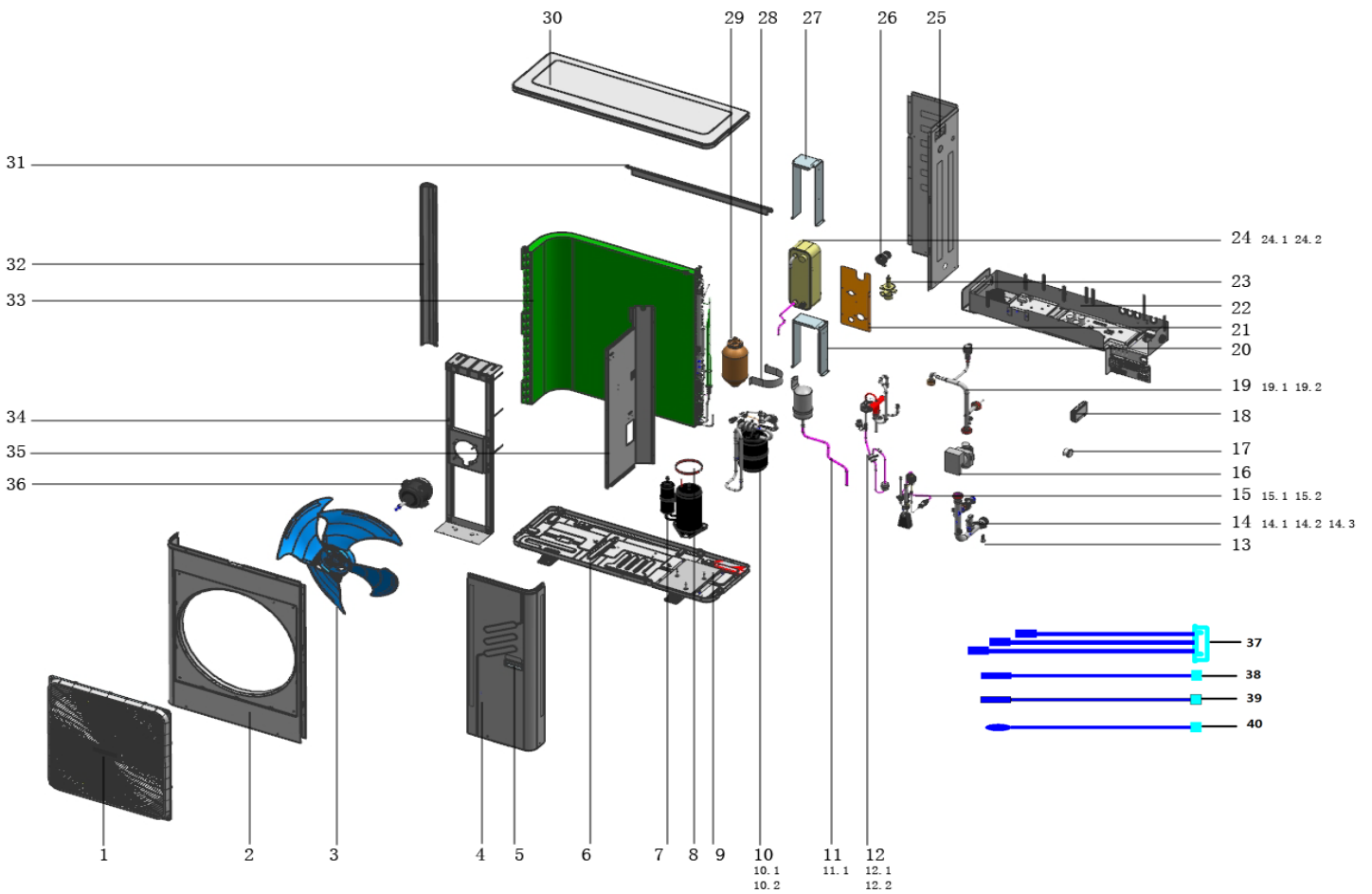
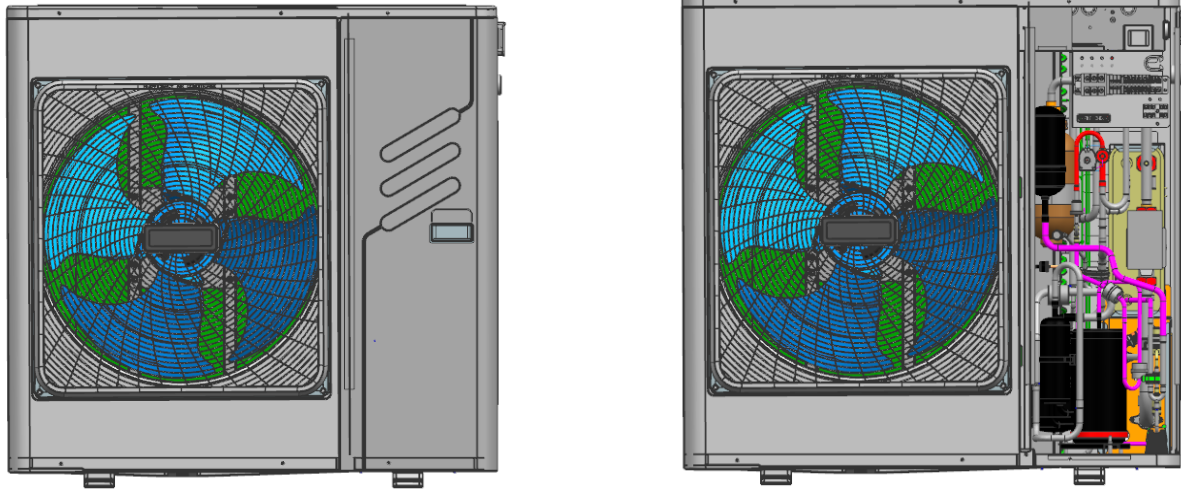

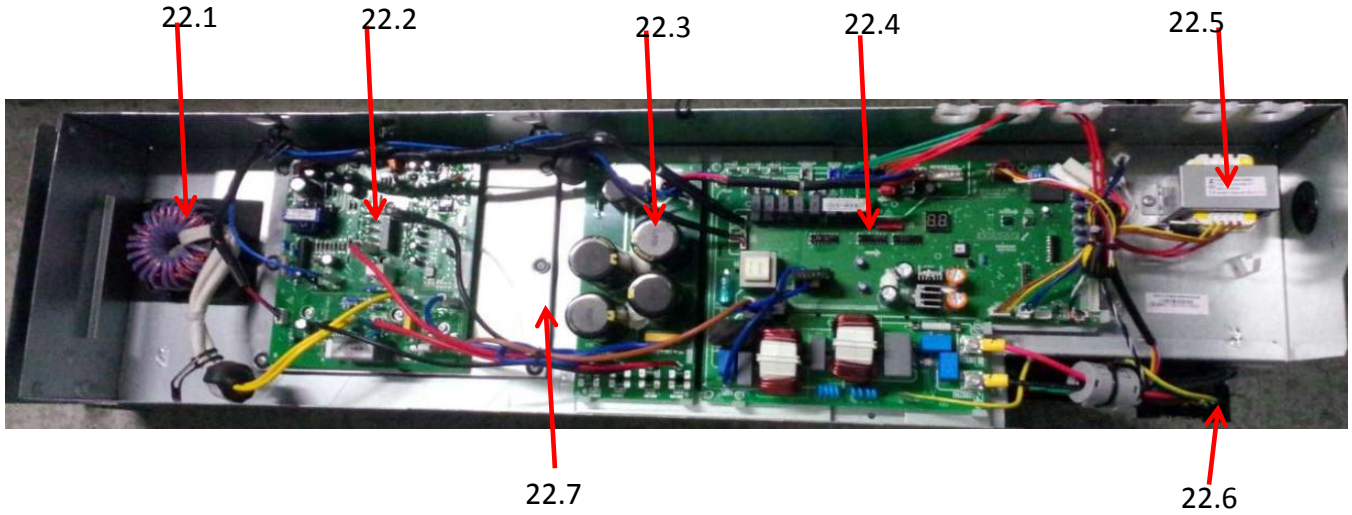

No.	Part Name	Quantity	No.	Part Name	Quantity
1	Grille	1	20	Heat-exchanger base ass'y	1
2	Front panel	1	21	Water inlet fixing board ass'y	1
3	Axial fan ass'y	1	22	E-part box ass'y	1
4	Side plate ass'y of front	1	22.1	PFC inductance	1
5	Handle	1	22.2	Inverter module ass'y	1
6	Base plate parts	1	22.3	Power supply board ass'y,outdoor unit	1
7	Compressor	1	22.4	Main control board	1
8	Crankcase electric heater	1	22.5	Transformer	1
9	Base supporter	1	22.6	Wire joint	1
10	Liquid accumulator ass'y	1	22.7	Radiator	1
10.1	Accumulator	1	23	Water charge valve	1
10.2	Pressure switch	1	24	Plate heat exchanger ass'y	1
11	Liquid accumulator ass'y	1	24.1	Plate heat exchanger	1
11.1	Accumulator	1	24.2	Electrical heater of plate heat exchanger	1
12	4-way valve ass'y	1	25	Side plate ass'y of rear	1
12.1	Pressure switch	1	26	Convert joint	1
12.2	4-way valve	1	27	Fixing board ass'y	1
13	Drain pipe adapter	2	28	Clamp	1
14	Water-out pipe ass'y	1	29	Expansion vessel	1
14.1	Water flow switch	1	30	Top cover parts	1
14.2	Safety valve	1	31	Rear net frame	1
14.3	Electrical heater of differential pressure valve	1	32	Left supporting board	1
15	EXV ass'y	1	33	Condenser	1
15.1	EEV solenoid	1	34	Motor bracket	1
15.2	Electronic expansion valve	1	35	Partition board	1
16	Pump	1	36	DC motor	1
17	Hydraulic meter	1	37	Pipe temp. sensor ass'y	1
18	Display box ass'y	1	38	Pipe Temp. sensor ass'y	1
19	Water-in pipe ass'y	1	39	Discharge Temp. sensor ass'y	1
19.1	Exhaust valve	1	40	Room Temp. sensor ass'y	1
19.2	Electrical heater of differential pressure valve	1			

MGC-V10W/D2N1, MGC-V12W/D2N1

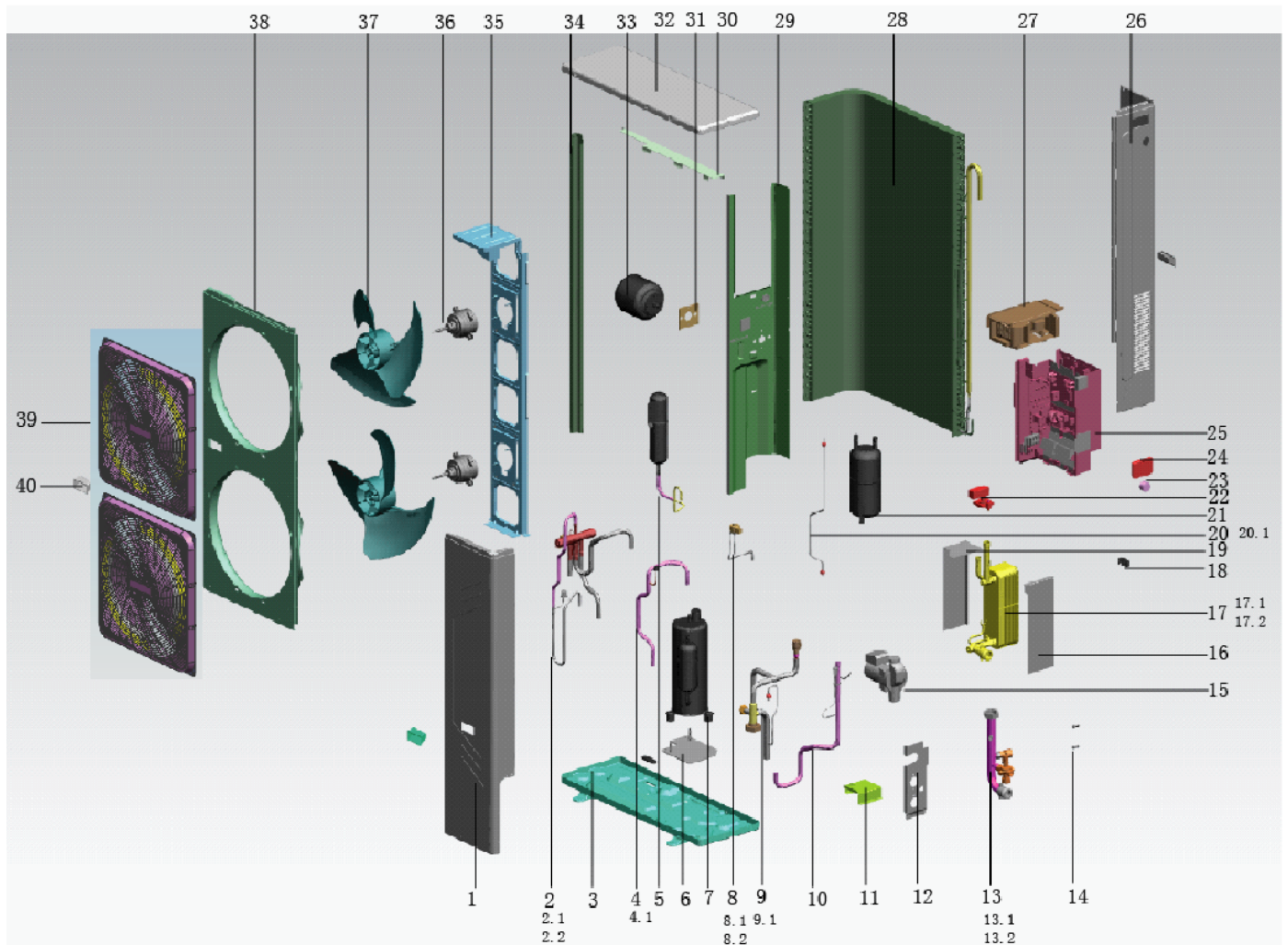
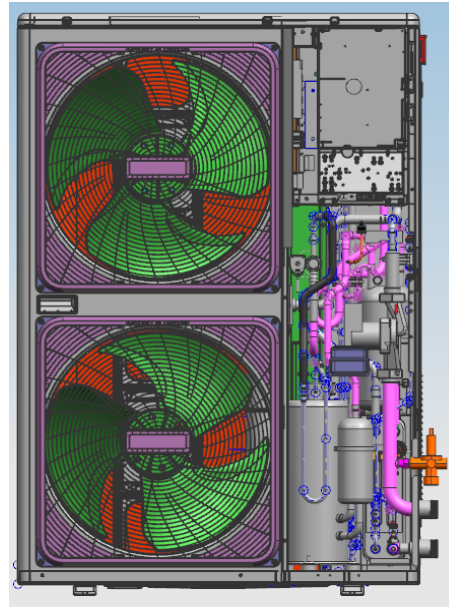
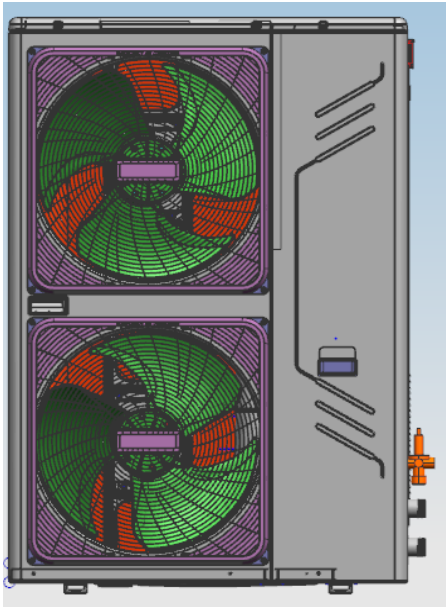

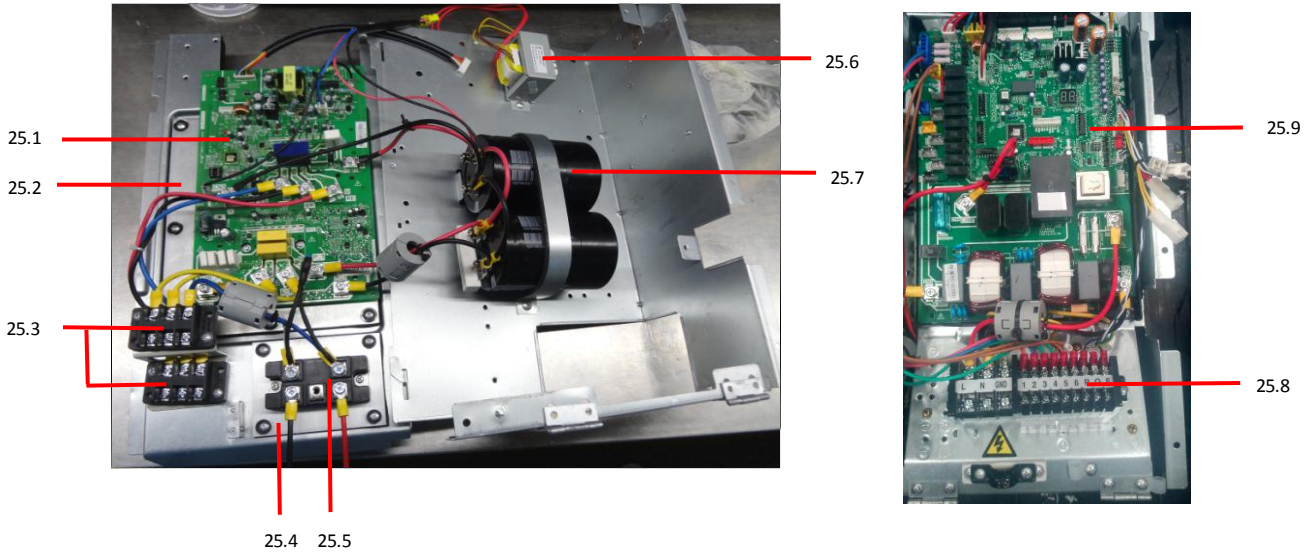

No.	Part Name	Quantity	No.	Part Name	Quantity
1	Right-front plate ass'y	1	21	Gas-liquid separator	1
2	Four-way valve parts	1	22	Differential pressure switch	1
2.1	Four-way valve ass'y	1	23	Hydraulic meter	1
2.2	Pressure switch	1	24	Display box ass'y	1
3	Welded parts of base	1	25	Outdoor electrical control box ass'y	1
4	Suction pipe ass'y	1	25.1	Module board ass'y	1
4.1	Pressure controller	1	25.2	Radiator	1
5	Accumulator ass'y	1	25.3	Terminal block, 3P	2
6	Fixed plate ass'y of compressor	1	25.4	Radiator	1
7	Compressor	1	25.5	Three phase bridge	1
8	EXV ass'y	1	25.6	Transformer	1
8.1	Electronic expansion valve	1	25.7	Electrolytic capacitor	2
8.2	Expansion valve wire(CAM-MD12GRSZ-5)	1	25.8	Wire joints, 12P	1
9	Exhaust valve ass'y	1	25.9	Outdoor control board ass'y	1
9.1	Exhaust valve	1	26	Right back plate	1
10	Connection pipe ass'y	1	27	Inductance Box Ass'y	1
11	Base	1	27.1	PFC Inductor	2
12	Fixed plate of inlet/outlet pipe	1	28	Condenser ass'y	1
13	Connection pipe parts of water pump	1	29	Coaming ass'y	1
13.1	Water charge valve	1	30	Bracket ass'y, net	1
13.2	Safety valve	1	31	Installation plate of expansion tank	1
14	Drain pipe adapter	2	32	Top cover ass'y	1
15	Water pump	1	33	Expansion vessel	1
16	Coaming I	1	34	Rear-left supporting board	1
17	Plate heat exchanger ass'y	1	35	Motor bracket assembly	1
17.1	Electrical heater of plate heat exchanger	1	36	DC Motor	2
17.2	Plate heat exchanger	1	37	Axial fan	2
18	Rubber gasket	1	38	Front Panel	1
19	Coaming II	1	39	Net	2
20	Connection pipe ass'y of differential pressure valve	1	40	Handle	3
20.1	Electrical heater of differential pressure valve	1			

MGC-V12W/D2RN1, MGC-V14W/D2RN1, MGC-V16W/D2RN1

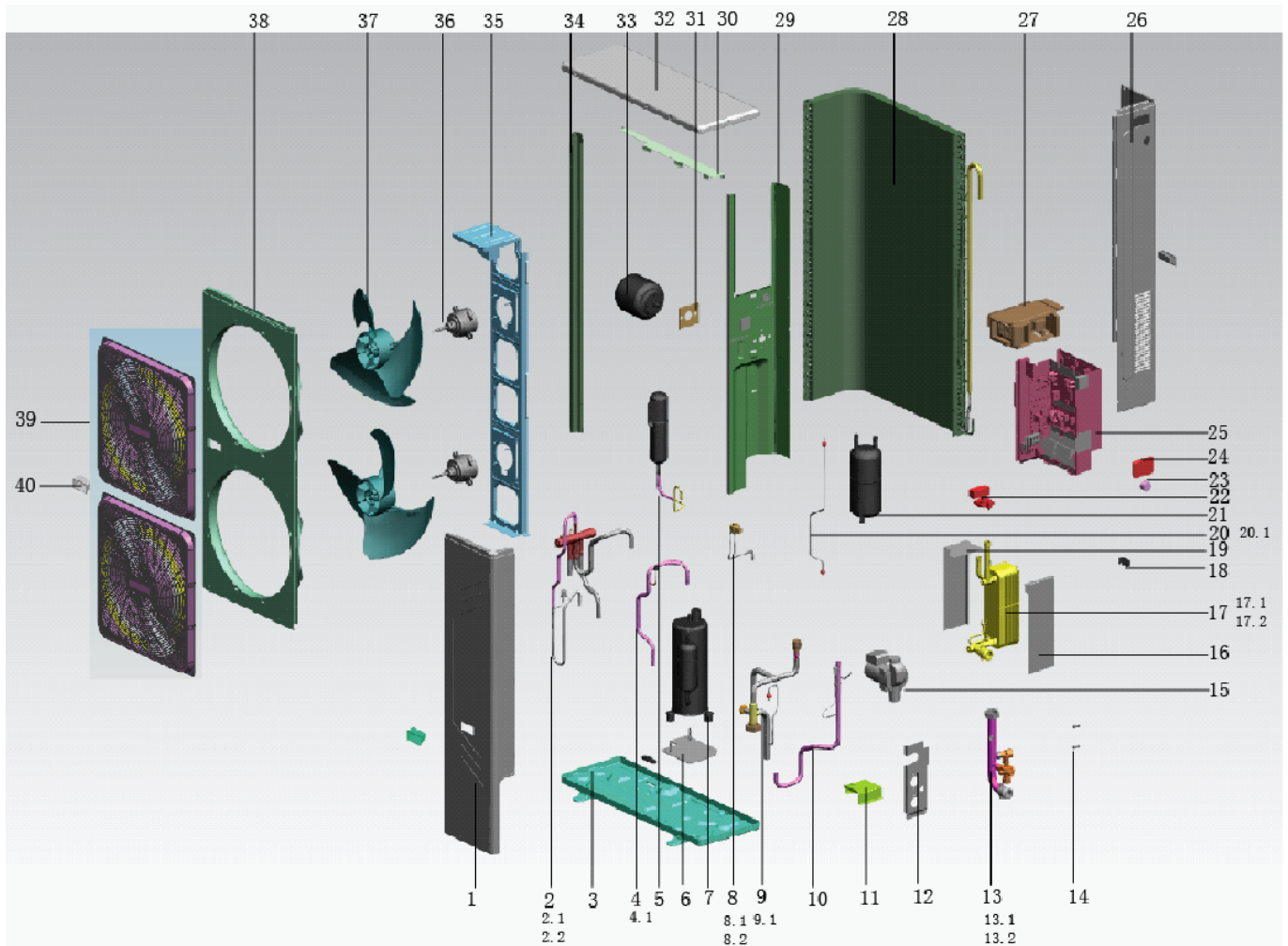
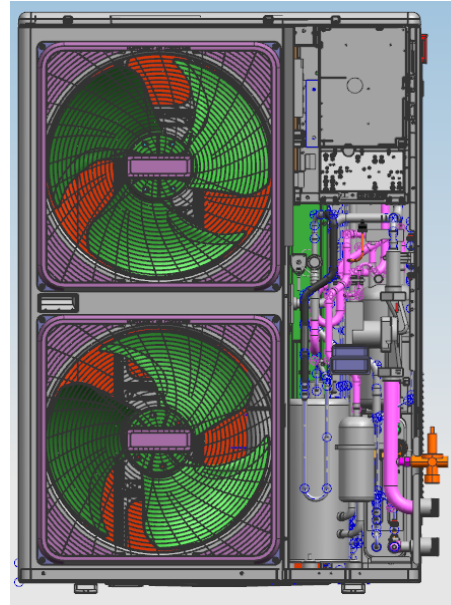
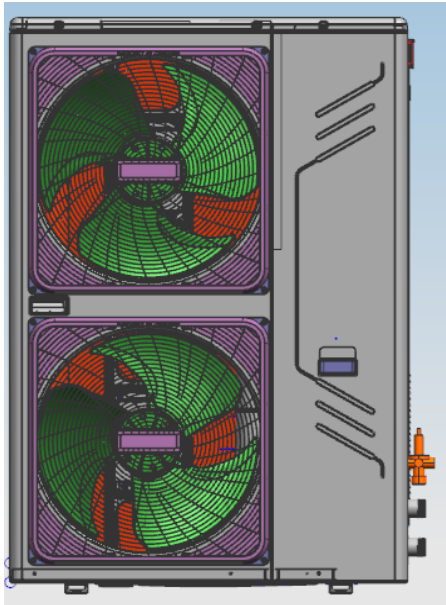

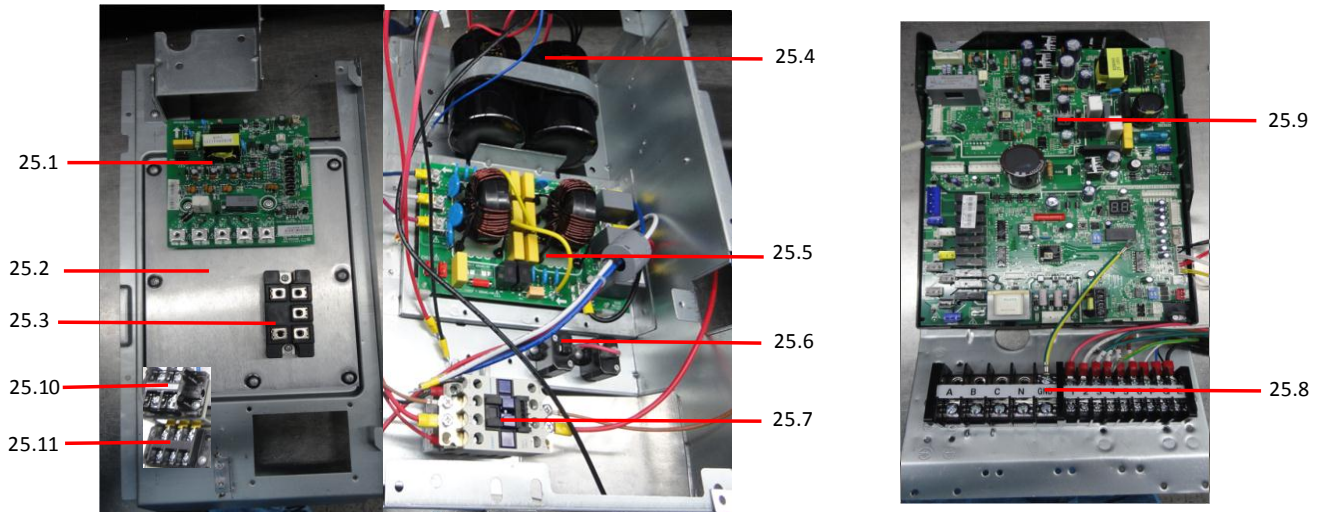

No.	Part Name	Quantity	No.	Part Name	Quantity
1	Right-front plate ass'y	1	22	Differential pressure switch	1
2	Four-way valve parts	1	23	Hydraulic meter	1
2.1	Four-way valve ass'y	1	24	Display box ass'y	1
2.2	Pressure switch	1	25	Outdoor electrical control box ass'y	1
3	Welded parts of base	1	25.1	Inverter module	1
4	Suction pipe ass'y	1	25.2	Radiator	1
4.1	Pressure controller	1	25.3	Three phase bridge	1
5	Accumulator ass'y	1	25.4	Aluminum electrolytic capacitors	2
6	Fixed plate ass'y of compressor	1	25.5	outdoor unit power supply board	1
7	Compressor	1	25.6	Resistance	2
8	EXV ass'y	1	25.7	AC contactor	1
8.1	Electronic expansion valve	1	25.8	Wire joints, 14P	1
8.2	Expansion valve wire(CAM-MD12GRSZ-5)	1	25.9	Outdoor main control board ass'y	1
9	Exhaust valve ass'y	1	25.10	Wire joint, 2p	1
9.1	Exhaust valve	1	25.11	Terminal block, 3P	1
10	Connection pipe ass'y	1	26	Right back plate	1
11	Base	1	27	Inductance parts ass'y	1
12	Fixed plate of inlet/outlet pipe	1	27.1	Reactance	1
13	Connection pipe parts of water pump	1	28	Condenser ass'y	1
13.1	Water charge valve	1	29	Coaming ass'y	1
13.2	Safety valve	1	30	Bracket ass'y, net	1
14	Drain pipe adapter	2	31	Installation plate of expansion tank	1
15	Water pump	1	32	Top cover ass'y	1
16	Coaming I	1	33	Expansion vessel	1
17	Plate heat exchanger ass'y	1	34	Rear-left supporting board	1
17.1	Plate heat exchanger	1	35	Motor bracket assembly	1
17.2	Electrical heater of plate heat exchanger	1	36	DC Motor	2
18	Rubber gasket	1	37	Axial fan	2
19	Coaming II	1	38	Front Panel	1
20	Connection pipe ass'y of differential pressure valve	1	39	Net	2
20.1	Electrical heater of differential pressure valve	1	40	Handle	3
21	Gas-liquid separator	1			

## 15. Installation

### 15.1 Installation of general information

#### General warning

1. These units have been designed to chilled and hot water and must be used in applications compatible with their performance characteristics; these appliances are designed for residential or similar applications.
2. Incorrect installation, regulation and maintenance or improper use absolves the manufacturer from all liability, whether contractual or otherwise, for damage to people, animals or things. Only those applications specifically indicated in this list are permitted.
3. Read this manual carefully. All work must be carried out by qualified personnel in conformity with legislation in force in the country concerned.
4. The guarantee is invalidated if the above instructions are not respected and if the unit is started up for the first time without the presence of personnel authorized by the Company (where specified in the supply contract) who should draw up a "start-up" report.
5. The documentation supplied with the unit must be consigned to the owner who should keep it carefully for future consultation in the event of maintenance or service.
6. All repair or maintenance work must be carried out by the Company's Technical Service or qualified personnel following the instructions in this manual. The air-conditioner must under no circumstances be modified or tampered with as this may create situations of risk. Failure to observe this condition absolves the manufacturer of all liability for resulting damage.

#### Fundamental safety rules

When operating equipment involving the use of electricity and water, a number of fundamental safety rules must be observed, namely:



#### Prohibition

1. This appliance is not intended for use by persons (including children) with reduced physical, sensory or mental capabilities, or lack of experience and knowledge, unless they have been given supervision or instruction concerning use of the appliance by a person responsible for their safety.
2. Do not touch the unit with bare feet or with wet or damp parts of the body.
3. Do not carry out cleaning operations without first disconnecting the system from the electricity supply.
4. Do not modify safety or regulation devices without authorization and instructions from the manufacturer.
5. Do not pull, detach or twist the electrical cables coming from the unit, even when disconnected from the mains electricity supply.
6. Do not open doors or panels providing access to the internal parts of the unit without first ensuring that the mains switch is in the off position.
7. Do not introduce pointed objects through the air intake and outlet grills.
8. Do not dispose of, abandon or leave within reach of children packaging materials (cardboard, staples, plastic bags, etc.) as they may represent a hazard.



#### Important

1. The chiller appliances are supplied without the main switch. The power supply to the unit must be disconnected using a suitable main switch that must be supplied and installed by the installer.
2. Respect safety distances between the unit and other equipment or structures. Guarantee adequate space for access to the unit for maintenance and/or service operations.

Power supply: the cross section of the electrical cables must be adequate for the power of the unit and the power supply voltage must correspond with the value indicated on the respective units. All units must be earthed in conformity with legislation in force in the country concerned.

3. Hydraulic connections should be carried out as indicated in the instructions to guarantee correct operation of the unit. Empty the water circuit or add glycol if the unit is not used during the winter. Handle the unit with the utmost care to avoid damage.

## 15.2 Installation of outdoor unit

### Choice of installation site

Before installing the unit, agree with the customer the site where it will be installed, taking the following points into consideration:

- Check that the fixing points are adequate to support the weight of the unit.
- Pay scrupulous respect to safety distances between the unit and other equipment or structures to ensure that air entering the unit and discharged by the fans is free to circulate.

### Positioning

Before handling the unit, check the capacity of the lifting equipment used, respecting the instructions on the packaging.

To move the unit in the horizontal, make appropriate use of a lift truck or similar, bearing in mind the weight distribution of the unit. To lift the unit, insert tubes long enough to allow positioning of the lifting slings and safety pins in the feet on the unit.

To avoid the slings damaging the unit, place protection between the slings and the unit. Position the unit in the site indicated by the customer. Place either a layer of rubber (min. thickness 10 mm) or vibration damper feet (optional) between the base and support surface. Fix the unit, making sure it is level and that there is easy access to hydraulic and electrical components. If the site of installation is exposed to strong winds, fix the unit adequately to the support surface using tie rods if necessary. If a heat pump unit is being installed, make sure the condensate is drained using the drain hose supplied as standard. Prevent leaves, branches or snow from accumulating around the unit. These could reduce the efficiency of the unit.

### Installation space (units: mm)

1. Since the gravity center of the unit is not at its physical center, so please be careful when lifting it with a sling.
2. Never hold the inlet of the outdoor unit to prevent it from deforming.
3. Do not touch the fan with hands or other objects.
4. Do not lean it more than 45°C, and do not lay it sidelong.
5. Make concrete foundation according to the specifications of the outdoor units.
6. Fasten the feet of this unit with bolts firmly to prevent it from collapsing in case of earthquake or strong wind.

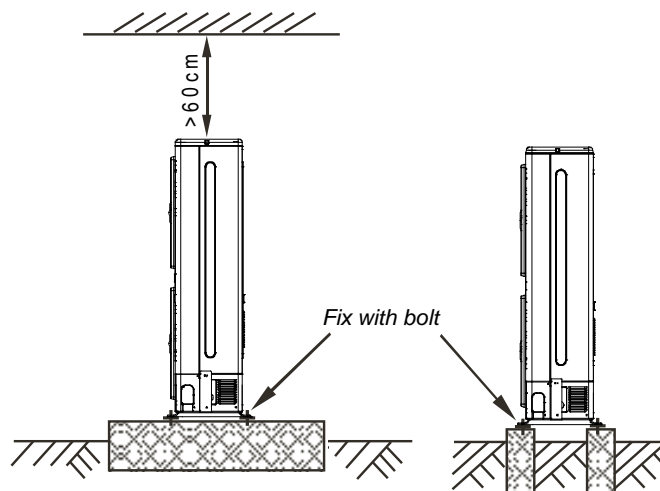



### Single unit installation

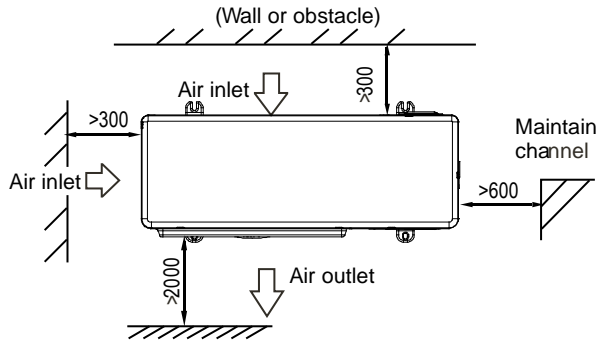

### Parallel connect two units or above

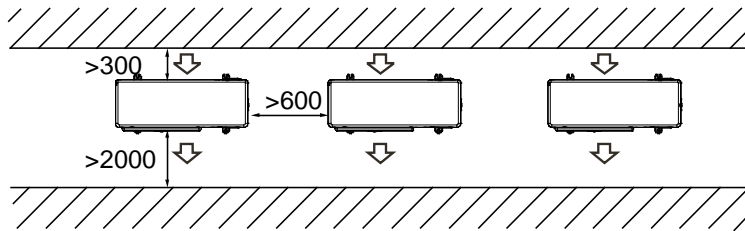

### Parallel connect the front with rear sides

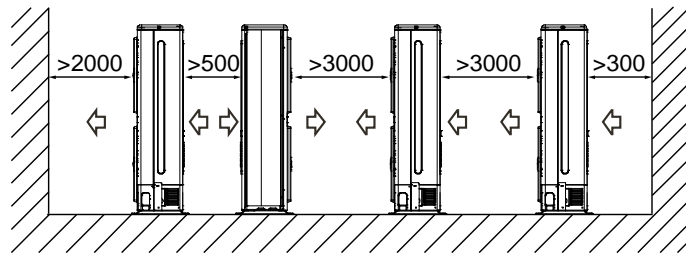

All the pictures in this manual are for explanation purpose only. They may be slightly different from the air conditioner you purchased (depend on model). The actual shape shall prevail.

### 15.3 Hydraulic connection

The choice and installation of components is the responsibility of the installer who should follow good working practice and current legislation. Before connecting the pipes, make sure they do not contain stones, sand, rust, or others which might damage the unit. Construction of a bypass is recommended to enable the pipes to be washed through without having to disconnect the unit (see drain valves). The connection piping should be supported in such a way as to avoid it weighing on the unit. It is recommended that the following devices are installed in the water circuit of the evaporator. A hydraulic safety valve shall be mounted in water system, which should open constantly.

**Connecting drawing of pipeline system  
MGC-V5W/D2N1 & MGC-V7W/D2N1**

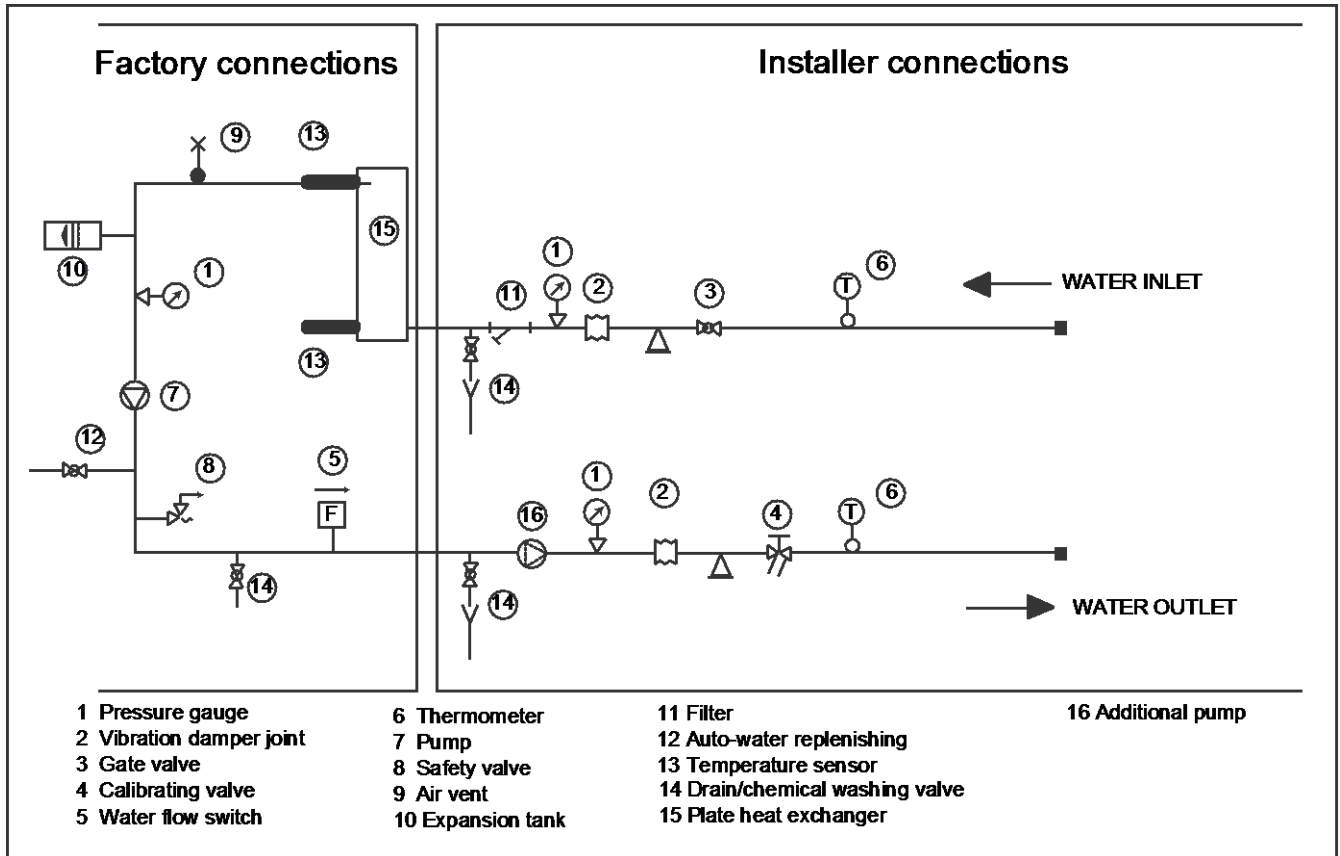

**MGC-V10W/D2N1, MGC-V12W/D2N1, MGC-V12W/D2RN1, MGC-V14W/D2RN1 & MGC-V16W/D2RN1**

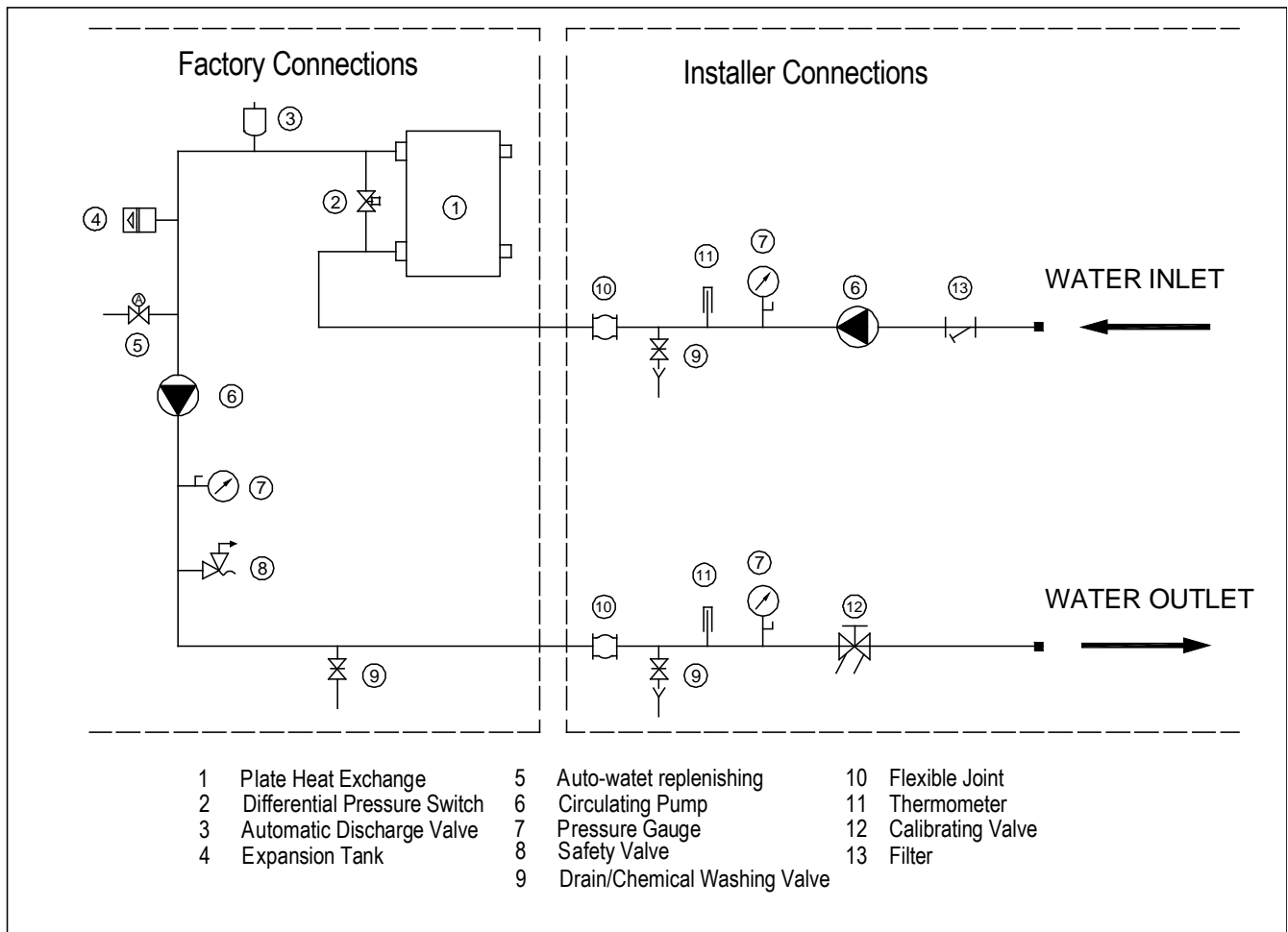

If the installation requires a useful head higher than that obtained by installing a pump assembly and storage tank, it is recommended that an additional pump is installed on the unit. Provided the additional pump installed inside of unit, the pump must be connected close to plate heat exchanger. Provided the pump installed outside of unit, the pump shall be connected at water pipe's outlet. The pump can be easily installed in the unit by removing the pump connection pipe. Connect to terminal PL, PN on the electric panel.

**⚠ Important**

- 1) The chillers must be provided with a filling/top-up system connected to the return line and a drain cock in the lowest part of the installation. Installations containing anti-freeze or covered by specific legislation must be fitted with hydraulic disconnections.
- 2) The manufacturer is not liable for obstruction, breakage or noise resulting from the failure to install filters or vibration dampers. Particular types of water used for filling or topping up must be treated with appropriate treatment systems.

**15.4 Design of the store tank in the system**

- kW is the unit for cooling capacity, L is the unit for (G) minimum water flow volume in the formula.

Comfortable type air conditioner

$$G = \text{cooling capacity} \times 2.6L$$

Process type cooling

$$G = \text{cooling capacity} \times 7.4L$$

- In certain occasion (especially in manufacture cooling process), for conforming the system water content requirement, it's necessary to mount a tank equipping with a cut-off baffle at the system to avoid water short-circuit, Please see the following schemes:

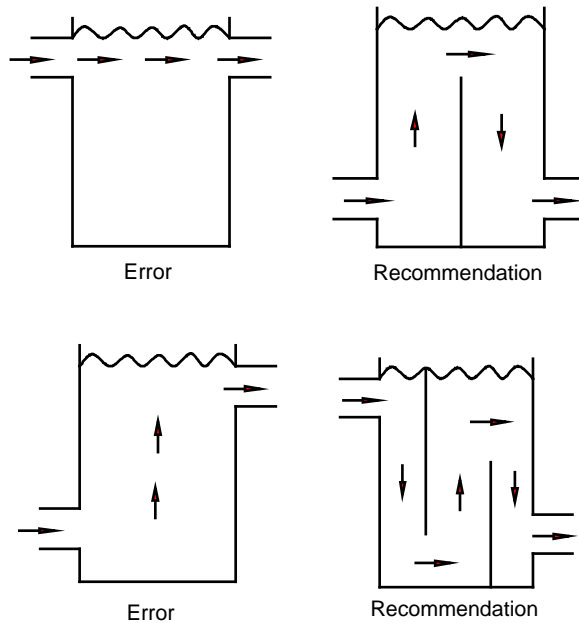

**15.5 Chilled water flow**

**Minimum chilled water flow**

The minimum chilled water flow is shown in the below table.

If the system flow is less than the minimum unit flow rate, the evaporator flow can be recalculated, as shown in the diagram.

For minimum chilled water flow rate

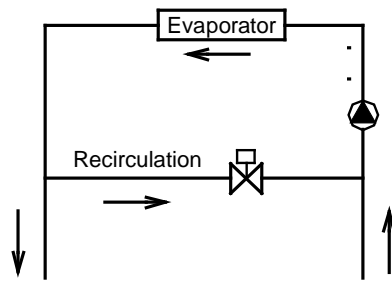

For maximum chilled water flow rate

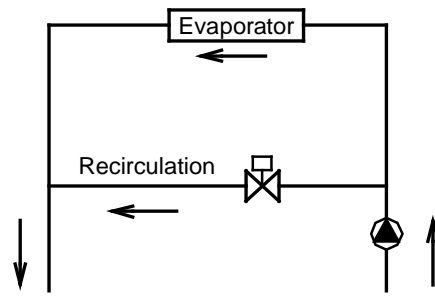

### Maximum chilled water flow

The maximum chilled water flow is limited by the permitted pressure drop in the evaporator. It is provided in the below table. If the system flow is more than the maximum unit flow rate, bypass the evaporator as shown in the diagram to obtain a lower evaporator flow rate.

### Minimum and maximum water flow rates

Model \ Item	Water flow rate(m <sup>3</sup> /h)	
	Minimum	Maximum
MGC-V5W/D2N1	0.77	0.95
MGC-V7W/D2N1	1.08	1.32
MGC-V10W/D2N1	1.54	1.89
MGC-V12W/D2N1	1.72	2.11
MGC-V12W/D2RN1	1.72	2.11
MGC-V14W/D2RN1	1.93	2.36
MGC-V16W/D2RN1	2.24	2.73

### 15.6 Design of expansion tank

If a closed expansion tank with its filled volume of air is too small, the system pressure will easily exceed the maximum allowable pressure and cause water to discharge from the pressure relief valve, thus wasting water. If the closed tank is too large, when the water temperature drops, the system pressure may decrease to a level below the minimum allowable value and cause trouble in the air vent. Therefore, accurate sizing of a closed expansion tank is essential.

For diaphragm expansion tanks, the minimum volume of the water tank,  $V_t$ , gal (m<sup>3</sup>), can be calculated by the following formula, recommended by ASHRAE Handbook 1996, HVAC Systems and Equipment:

$$V_t = V_s \left\{ \frac{v_2/v_1 - 1 - 3\alpha(T_2 - T_1)}{1 - p_1/p_2} \right\}$$

$T_1$ =lower temperature, °F (°C)

$T_2$ =higher temperature, °F (°C)

$V_s$ =volume of water in system, gal(m<sup>3</sup>)

$p_1$ =absolute pressure at lower temperature, psia (kPa abs.)

$p_2$ =absolute pressure at higher temperature, psia (kPa abs.)

$v_1, v_2$  =specific volume of water at lower and higher temperature, respectively, ft<sup>3</sup>/lb(m<sup>3</sup>/kg)

$\alpha$  =linear coefficient of thermal expansion; for steel,  $\alpha = 6.5 \times 10^{-6} \text{in./in} \cdot ^\circ\text{F}$  ( $1.2 \times 10^{-5} \text{per}^\circ\text{C}$ ); For copper,

$\alpha = 9.5 \times 10^{-6} \text{in./in} \cdot ^\circ\text{F}$  ( $1.7 \times 10^{-5} \text{per}^\circ\text{C}$ )

In a chilled water system, the higher temperature T2 is the highest anticipated ambient temperature when the chilled water system shuts down during summer. The lower temperature in a heating system is often the ambient temperature at fill conditions (for example, 50°F or 10°C).

### 15.7 Water quality control

When industrial water is used as chilled water, little furring may occur; however, well water or river water, used as chilled water, may cause much sediment, such as furring, sand, and so on. Therefore, well water or river water must be filtered and softened in softening water equipment before flowing into chilled water system. If sand and clay settle in the evaporator, circulation of chilled water may be blocked, and thus leading to freezing accidents; if hardness of chilled water is too high, furring may occur easily, and the devices may be corroded. Therefore, the quality of chilled water should be analyzed before being used, such as PH value, conductivity, concentration of chloride ion, concentration of sulfide ion, and so on.

PH	6~8
Total hardness	less than 50 ppm
Electrical conductivity	less than 200 mV/cm (25℃)
Sulfide ion	none
Chlorine ions	less than 50 ppm
Ammonia ions	none
Sulfate ion	less than 50 ppm
Silicon	less than 30 ppm
Total iron	less than 0.3 ppm
Sodium ion	No requirement
Calcium ion	less than 50 ppm

#### Filling the installation

- Before filling, check that the installations drain cock is closed.
- Open all installation and terminal air vents.
- Open the gate valves.
- Begin filling, slowly opening the water filling cock outside the unit.
- When water begins to leak out of the terminal air vent valves, close them and continue filling until the pressure gauge indicates a pressure of 1.5 bars.

#### Emptying the installation

- Before emptying, place the mains switch in the “off” position.
- Make sure the installation fill/top-up water cock is closed.
- Open the drain cock outside the unit and all the installation and terminal air vent valves.

## Size and position of connections

### For MGC-V5W/D2N1 & MGC-V7W/D2N1

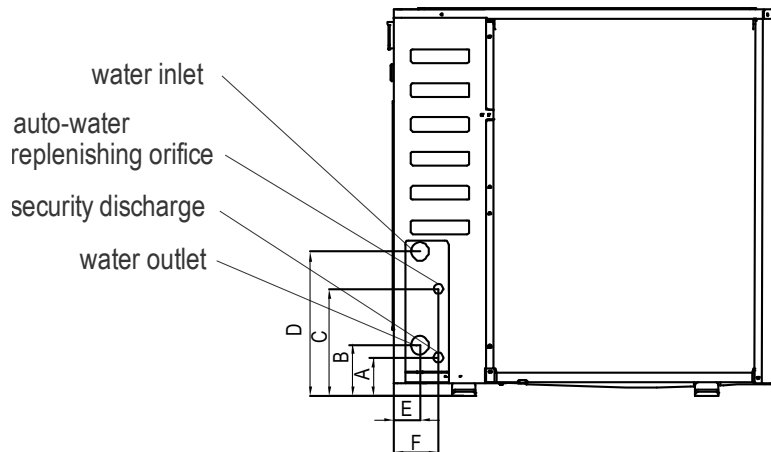

Model	A (mm)	B (mm)	C (mm)	D (mm)	E (mm)	F (mm)	Water inlet/outlet (Ø)	Auto-water replenishing (Ø)	Security discharge (Ø)
MGC-V5W/D2N1 MGC-V7W/D2N1	95	126	250	360	68	114	R1	G1/2	G1/2

### For MGC-V10W/D2N1, MGC-V12W/D2RN1, MGC-V14W/D2RN1, MGC-V16W/D2RN1

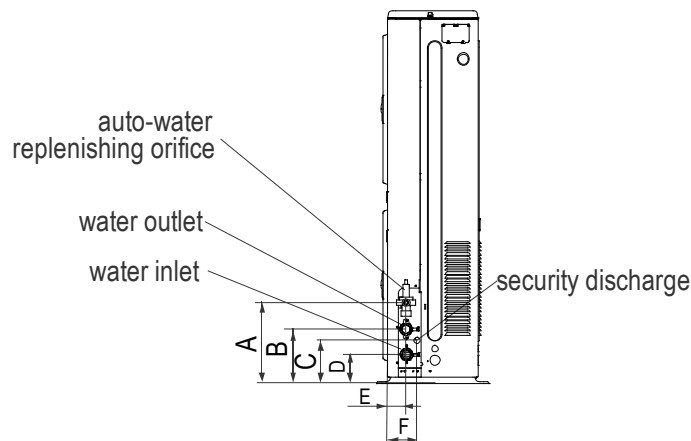

Model	A (mm)	B (mm)	C (mm)	D (mm)	E (mm)	F (mm)	Water inlet/outlet (Ø)	Auto-water replenishing (Ø)	Security discharge (Ø)
MGC-V10W/D2N1 MGC-V12W/D2N1 MGC-V12W/D2RN1 MGC-V14W/D2RN1 MGC-V16W/D2RN1	300	195	155	105	68	105	R5/4	G1/2	G1/2

### Important

- The installation must be filled to a pressure of between 1 and 2 bars.
- It is recommended that this operation be repeated after the unit has been operating for a number of hours. The pressure of the installation should be checked regularly and if it drops below 1 bar, the water content should be topped-up.
- Check the hydraulic tightness of joints.
- An all-pole disconnection device which has at least 3mm separation distance in all pole and a residual current device (RCD) with the rating of above 10mA shall be incorporated in the fixed wiring according to the

national rule the appliance shall be installed in accordance with national wiring regulations.

e) If the fluid in the circuit contains anti-freeze, it should not be allowed to drain freely as it is pollutant. It should be collected for possible reuse. When draining after heat pump operation, take care as the water may be hot (up to 50°).

### 15.8 Electrical connection

The unitary mini chillers leave the factory already wired, and require the installation of an omni polar thermal overload switch, a lockable mains disconnecting switch for the connection to the mains power supply, and the connection of the flow switch to the corresponding terminals. All the above operations must be carried out by qualified personnel in compliance with the legislation in force.

For all electrical work, refer to the electrical wiring diagrams in this manual. You are also recommended to check that the characteristics of the mains electricity supply are adequate for the absorptions indicated in the electrical characteristics table below, also bearing in mind the possible use of other equipment at the same time.



#### Important

- Power to the unit must be turned on only after installation work (hydraulic and electrical) has been completed.
- All electrical connections must be carried out by qualified personnel in accordance with legislation in force in the country concerned.
- Respect instructions for connecting phase, neutral and earth conductors.
- The power line should be fitted upstream with a suitable device to protect against short-circuits and leakage to earth, isolating the installation from other equipment.
- Voltage must be within a tolerance of  $\pm 10\%$  of the rated power supply voltage for the unit (for three phase units, the unbalance between the phases must not exceed 3%). If these parameters are not respected, contact the electricity supply company.
- For electrical connections, use double insulation cable in conformity with current legislation in the country concerned.
- An omnipolar thermal overload switch and a lockable mains disconnecting switch, in compliance with the CEI-EN standards (contact opening of at least 3mm), with adequate switching and residual current protection capacity based on the electrical data table shown below, must be installed as near as possible to the appliance.
- The devices on the unit must be lockable. An efficient earth connection is obligatory. Failure to earth the appliance absolves the manufacturer of all liability for damage.
- Do not use water pipes to earth the unit.

■ **Electrical Panel**

The electrical panel is located inside the unit at the top of the technical compartment where the various components of the refrigerant circuit are also to be found.

To access the electrical panel, remove the front panel of the unit by undoing the screws.

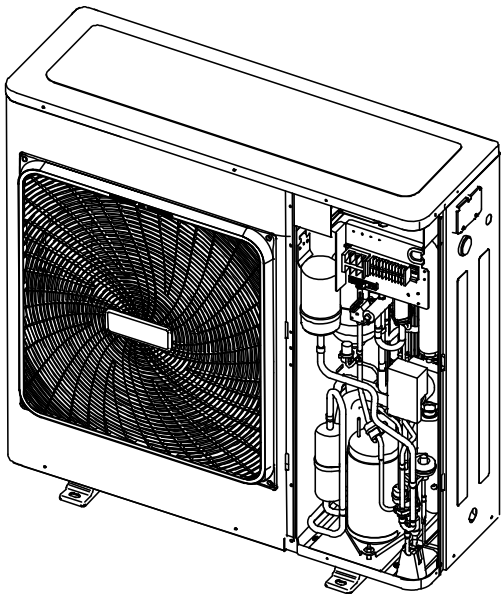

5/7kW

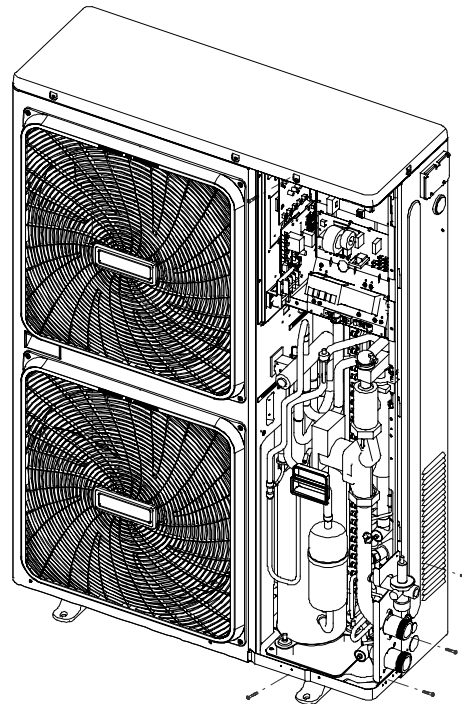

10~16kW

■ **Electrical Power Connection**

MGC-V5W/D2N1, MGC-V7W/D2N1, MGC-V10W/D2N1, MGC-V12W/D2N1

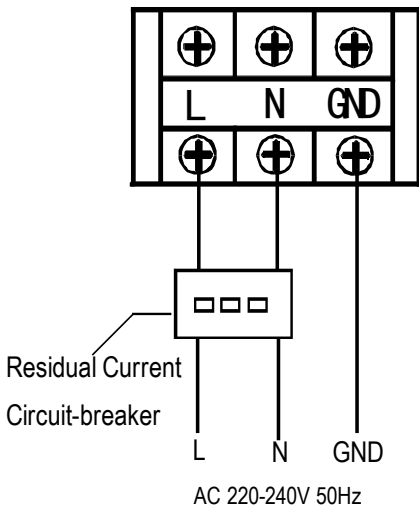
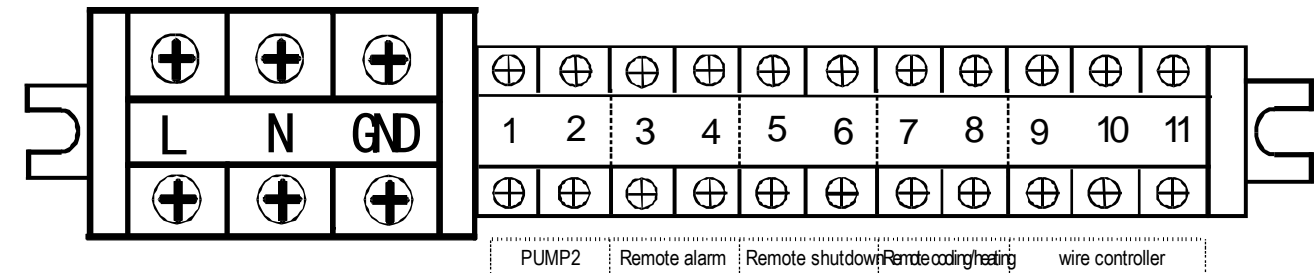

NOTE: The outdoor units must be installed with a Residual Current Circuit-breaker near the power supply and must be effectively earthed.



**MGC-V12W/D2RN1, MGC-V14W/D2RN1, MGC-V16W/D2RN1**

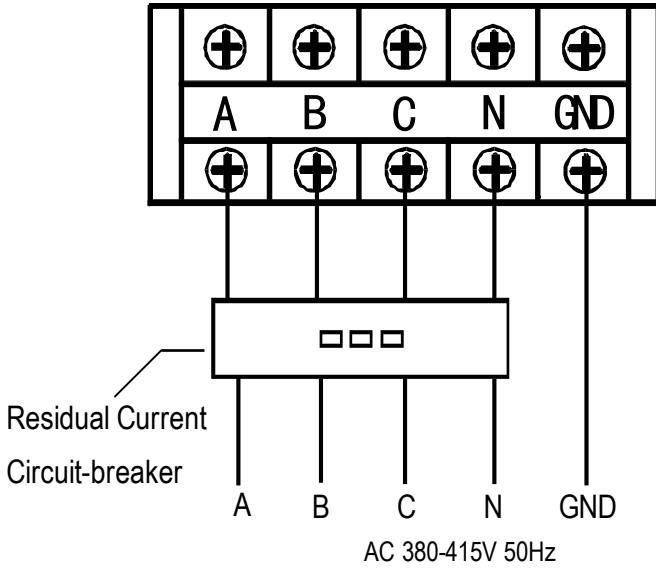
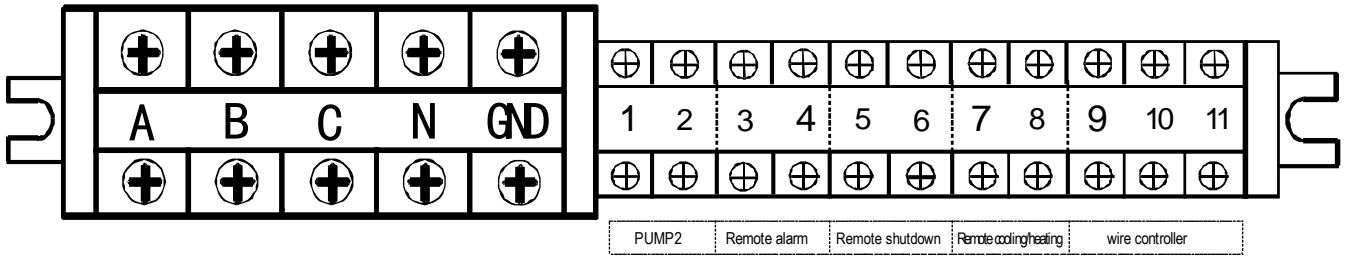

**Additional pump**

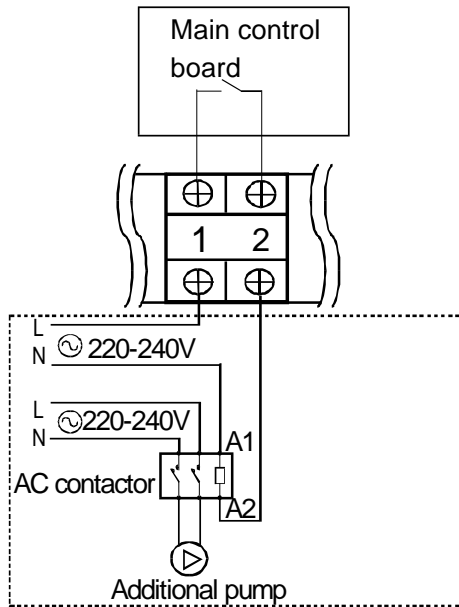

“PUMP2” terminal only provides passive switching signal.  
Additional water pump must be controlled by the AC contactor.

### ■ Remote alarm

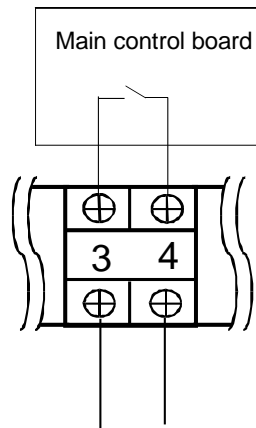

Remote alarm terminal only provides passive switching signal.

Current passing through the terminal interface should less than 1.5A, otherwise please use AC contactor to control load indirectly.

### ■ Remote shutdown

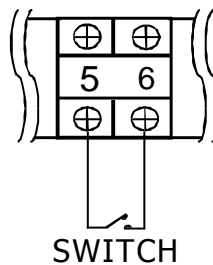

If switch is closed, the unit will be stopped forcibly.

Under this circumstance, anti-frozen protection and other protection functions are still effective.

If switch breaks, unit can run normally according settings.

### ■ Remote cooling/heating

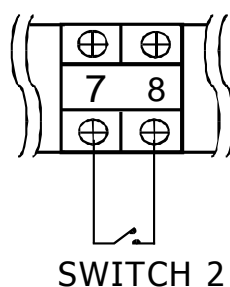

If switch 2 is closed, the unit will shift to heating mode forcibly;

If switch 2 is break, the unit will shift to cooling mode forcibly.

#### Note:

1. Remote shutdown and remote cooling/heating is optional function. Choose this function by DIP switch SW4\_1 (SW3\_1 for 12/14/16kW) on PCB board. Factory default has not set remote cooling/heating function.
2. When the remote control and wired controller used at the same time, the unit will carry out the last command of arbitrary terminal.
3. Remote shutdown has the highest priority. In the status of remote shutdown, other controllers can't start the unit.

■ Remote controller

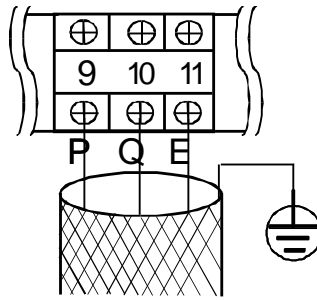

- The wired controller is optional.
- Please use 3-core shielded wire to connect the wired controller and the shielding layer must be grounded.
- When connecting wired controller, outdoor unit control panel is mainly used for display which can check parameters and inquiry, can't be used to set mode and temperature.

**The Specification of Power:**

Type	MGC-V5W/D2N1	MGC-V7W/D2N1	MGC-V10W/D2N1 MGC-V12W/D2N1	MGC-V12W/D2RN1 MGC-V14W/D2RN1 MGC-V16W/D2RN1
Power(V/Ph/Hz)	220~240/1/50	220~240/1/50	220~240/1/50	380~415/3/50
Circuit breaker/fuse (A)	25/20	30/25	40/35	30/25
Power wire (mm <sup>2</sup> )	3×2.5	3×2.5	3×6.0	5×4.0
Ground wire (mm <sup>2</sup> )	2.5	2.5	4.0	2.5

**⚠ Important**

The power cord type designation is H07RN-F.

Connecting cable between indoor unit and outdoor unit shall be approved poly-chloroprene sheathed flexible cord, type designation H07RN-F or heavier cord.

The means for disconnection from a power supply shall be incorporated in the fixed wiring and have an air gap.

## 16. Checking and Starting Up the Unit

### Preparing for first start up

Restart after shutting down for long periods.

The chiller must be started up for the first time by the Technical Service. Before starting up the chillers, make sure that:

- All safety conditions have been respected.
- The chiller is adequately fixed to the surface it rests on.
- Functional distances have been respected.
- Hydraulic connections have been carried out as indicated in the manual.
- The water circuit is filled and vented. When draining after heat pump operation, take care as the water may be hot.
- The water circuit valves are open.
- Electrical connections have been carried out correctly.
- Voltage is within a tolerance of 10% of the rated voltage for the unit.
- The unit is correctly earthed.
- All electrical and hydraulic connections are tight and have been completed correctly.

Use grommet A for the electrical power cable and grommet B for the other external wires.

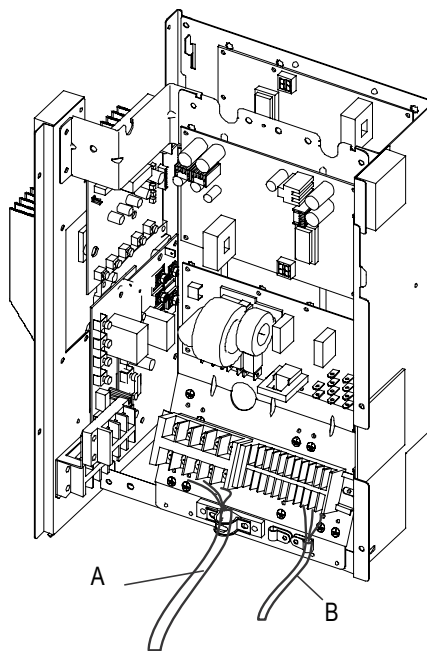

To complete the electrical connections:

- Remove the inspection panel by unscrewing the five screws. MGC-V10W/D2N1 for example:

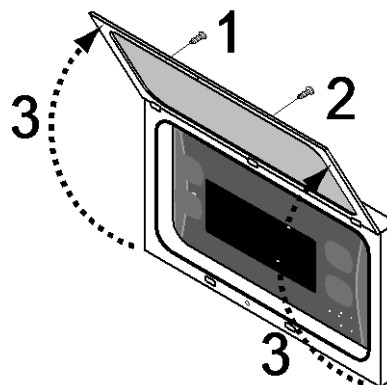
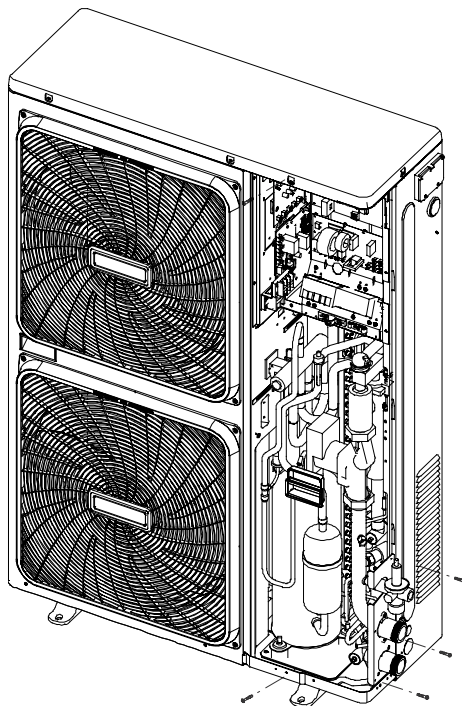

To access the control panel, open the door:

- remove the screw 1 and screw 2;
- lift the door 3.

## 17. Running and Maintenance

### 17.1 Operating characteristics

#### Set point in cooling mode

(Factory set) = 12°C, Hysteresis = 3°C.

The compressor starts with water temperatures above 12°C.

The compressor shuts down with water temperatures of less than 9°C.

#### Set point in heating mode

(Factory set) = 40°C, Hysteresis = 4°C.

The compressor starts with water temperatures below 38°C.

The compressor shuts down with water temperatures above 42°C.

In the event of a temporary power failure, when power returns, the mode set previously will be retained in the memory.

#### Compressor start up delay

- Minimum time since last start-up 300 seconds.

Two functions prevent the compressor from starting up too frequently

#### Pump

The electronic board includes a pump control output. The pump starts when the assembly is powered up and at least 285 seconds before the compressor starts up and stops 120 seconds after the assembly shuts down. After the first 120 seconds of pump operation when the water flow is at full speed, the water flow alarm functions are activated (differential pressure switch and flow switch). With a pump connected to terminals PL and PN on the installer terminal board.

#### Fan speed control

For correct operation of the unit with different outside temperatures, the microprocessor controls the fan speed based on the pressure reading from the pressure probe, thus enabling heat exchange to be increased and/or decreased, maintaining the condensing or evaporation temperature practically constant.

The fan functions independently of the compressor.

#### Frost prevention alarm

To prevent the water freezing and damaging the plate heat exchanger, the microprocessor shuts down the compressor if the temperature measured by the heat exchanger outlet temperature sensor is less than 3°C. The frost prevention temperature set point can be modified by an authorized service center only and only after verifying that the water circuit contains antifreeze. Tripping of this alarm shuts down the compressor but not the pump, which remains active. To reset normal functions, the outlet water temperature must rise to more than +15°C. Reset is manual.

#### Water flow alarm

The microprocessor provides for management of a water flow alarm controlled by a differential pressure switch fitted as standard on the appliance to be installed on the water delivery piping.

This safety device may trip after the first 120 seconds of pump operation when the water flow is up to speed.

Tripping of this alarm shuts down the compressor but not the pump, which remains active. To reset normal functions, the alarm contact must be deactivated for at least 15 seconds.

When electrical current exceeds to setting value and condenser temperature over than 62°C, system will shut down, but not returns to normal operation until the condenser temperature decreased less than 52°C.

## 17.2 Routine maintenance

Never perform any cleaning operations before having disconnected the unit from the mains power supply.

If the supply cord is damaged, it must be replaced by the manufacturer or its service agent or a similarly qualified manufacturer or its service agent or a similarly qualified.

Regular maintenance is fundamental to maintain the efficiency of the unit both in terms of operation and energy consumption. The Technical Assistance Service maintenance plan must be observed, with an annual service which includes the following operations and checks:

- Filling of the water circuit.
- Presence of air bubbles in the water circuit.
- Efficiency of safety devices.
- Power supply voltage.
- Power input.
- Tightness of electrical and hydraulic connections.
- Condition of the compressor contactor.
- Efficiency of the plate heat exchanger heater.
- Checking of operating pressure, superheating and sub cooling.
- Efficiency of compressor heater.
- Cleaning of finned coil (\*).
- Cleaning of fan grills.
- Cleaning of condensate drain pan (if installed).

(\*) For "Heat pump" appliances, the checks are to be performed quarterly.

For units installed near the sea, the intervals between maintenance should be halved.

## 17.3 Extraordinary maintenance

Never perform any cleaning operations before having disconnected the unit from the mains power supply.

### Chemical washing

You are recommended to chemically wash the plate heat exchanger after every 3 years of operation.

### Refrigerant gas content

The chillers are filled with R410a refrigerant gas and tested in the factory. In normal conditions, there should be no need for the Technical Assistance Service to intervene to check the refrigerant gas. However, over time, small leaks may develop at the joints leading to loss of refrigerant and draining of the circuit, causing the unit to function poorly. In this case, the leaks of refrigerant must be identified and repaired and the refrigerant circuit refilled. Proceed as follows:

- Empty and dry the entire refrigerant circuit using a vacuum pump connected to the low and high pressure tap until the vacuum meter reads about 10Pa. Wait a couple of minutes and check that this value does not rise to more than 200Pa.
- Connect the refrigerant gas cylinder or a filling cylinder to the low pressure line pressure gauge connection.
- Fill with the quantity of refrigerant gas indicated on the rating plate of the unit.
- Always check the superheating and sub cooling values. In the nominal operating conditions for the appliance, these should be between 5 and 10°C and between 4 and 8°C respectively.
- After a couple of hours of operation, check that the liquid indicator indicates circuit dry (dry-green).

 **Important**

In the event of partial leaks, the circuit must be completely emptied before being refilled.

The R410a refrigerant must only be filled in the liquid state. Operating conditions other than nominal conditions may produce considerably different values.

Seal testing or identification of leaks must only be carried out using R410a refrigerant gas, checking with a suitable leak detector.

 **Prohibition**

1. The refrigerant circuit must not be filled with a refrigerant other than that indicated of specification.
2. The use of a different refrigerant may cause serious damage to the compressor.
3. Oxygen, acetylene or other inflammable or poisonous gases must never be used in the refrigerant circuit as they may cause explosion or poisoning.
4. Oils other than those indicated on manual before must not be used. The use of different oils may cause serious damage to the compressor.

#### 17.4 Shutting down for long periods

If it is previewed not to use the machine for long periods

After deactivating the chiller:

-Make sure the model is in the power off model "  ", or alternatively disconnect the unit from the power supply.

-Make sure the remote control switch is closed (if present) .

-Close the water valves.

 **Important**

If there is a possibility that the outside temperature may drop below zero, there is the risk of freezing.

The water circuit **MUST BE EMPTIED AND SHUT OFF POWER** (when draining after heat pump operation take care as the water may be hot) or antifreeze must be added in the proportion recommended by the manufacturer.



## 18. Controller

### 18.1 Standard controller

It is built-in with the chiller at the factory.

The front panel of the device functions as the user interface and is used to perform all operations relating to the device.

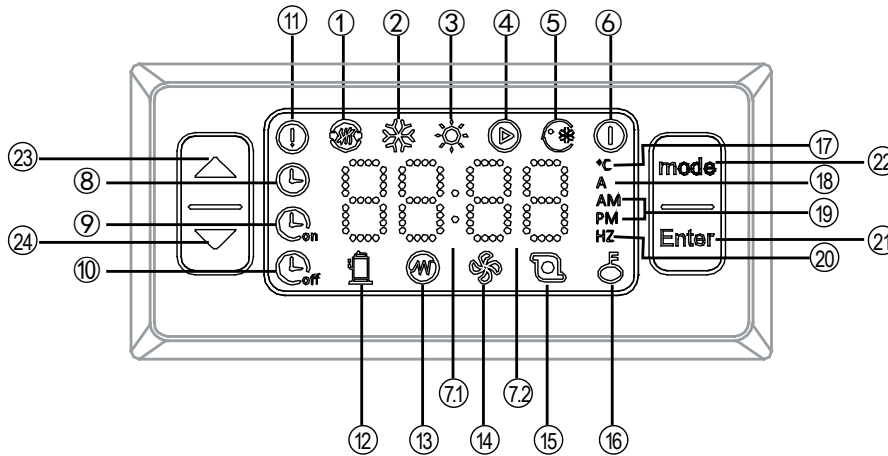

NO.	Icon	Description
①		Outside heat source running icon(Reserved)
②		Cooling mode icon This icon will be constantly light when customers choose cooling mode.
③		Heating mode icon This icon will be constantly light when customers choose heating mode.
④		Water pump mode icon This icon will be constantly light when customers choose water pump mode.
⑤		Force cooling icon This icon will be constantly light when customers choose force cooling mode.
⑥		Power off icon This icon will be constantly light when customers choose Power off mode.
⑦.1		Clock icon, “:” flash once every 1s. It will display time when customers set the timer.
⑦.2		The last 2 digits of the nixie tube “88” icon. If “88” is constantly light, it will display the current inlet water temperature. It’s unit is ℃.When customers do the water temperature setting, icon will display the setting water temperature. When checking, “88” will display the result of checking. When water heating is broken down or in protection, “88” display the error code and protection code.
⑧		Clock icon It will display when finish setting the clock and be extinguished when the clock setting work is done.
⑨		Timing on function icon will flash when setting timing on. The icon will be constantly light when finish setting.
⑩		Timing off function icon will flash when setting timing off. The icon will be constantly light when finish setting.
⑪		Breakdown light icon When the unit is broken down or under protection, this icon will flash and will be off when malfunction and protection are eliminated.
⑫		Compressor booting indicator icon When booting the compressor, this icon will be constantly light. It will be off when the compressor is shut down
⑬		E-heater booting indicator icon ( Reserved ) When booting the external E-heater, this icon will be constantly light. It will be off when the external E-heater is shut down.
⑭		Fan booting indicator icon When booting the fan, this icon will be constantly light. It will be off when the fan is shut down.
⑮		Water pump booting indicator icon When booting the water pump, this icon will be constantly light. It will be off when the water pump is shut down.
⑯		Key freezing icon When freezing the keys, this icon will be constantly light. It will be off when unfreezing keys.

⑰		Temperature unit icon When the control panel displays temperature, this icon will be constantly light.
⑱		Current unit icon When the control panel displays current, this icon will be constantly light.
⑲		Time format icon The unit is 12-hour format. "AM" will be constantly light when it is forenoon. "PM" will be constantly light when it is afternoon
⑳		Frequency unit icon It will be constantly light when the control panel displays frequency of the compressor.
㉑		ON/OFF and OK button 1. Long press "Enter" for 3S will power on or off the controller. 2. Press "Enter" to confirm the former operation when finishing the setting work.
㉒		Mode choice function/Function choice/Back function button 1. Mode choice function. Choose operation mode. 2. Function choice. Long press it for 3s to enter function setting in the main interface.(Clock setting, Timing on and timing off setting) 3. Back to the previous menu. Long press it for 3s to back to previous menu in the function setting interface. Top menu is the main interface.
㉓		Up 1.(Value increase) 2. Forward to the previous interface.
㉔		Down 1.(Value decrease) 2. Backward to the next interface.

### 18.1.1 Control panel operation description

#### 1) ON/OFF

The first time to power on the unit, operation panel displays "OFF". Long press "Enter" for 3s to unlock "OFF" status and enter into standby status.

Power on: In the standby status, press "mode" to enter mode choice function. Press "mode" circularly to choose one kind of "power on" mode, the mode icon will flicker at the moment. Press "Enter" to confirm the power on mode. The unit will run as the chosen mode when the mode icon will be constantly light.

Power off: Press "mode" in the main interface to enter mode choice function and the icon which indicate the current mode will flicker. Press "mode" circularly to choose power off mode, "⓪" will flicker at this moment. Press "Enter" button to confirm the power off mode. By this time, "⓪" will be constantly light and the unit stops.

#### 2) Mode choice and temperature settings

Press "mode" in the main interface to enter mode choice function. The "Mode" icon will flicker. Click "mode" circularly to choose a mode. The circulating order is "Cooling mode" → "Heating mode" → "Water pump mode" → "Power off mode" → "Cooling mode. The chosen mode will flicker. Press "▲" or "▼" to increase/decrease the temperature in the chosen mode.

Press "Enter" to confirm power off mode and the set temperature. Mode icon will be constantly light and the unit will run as the chosen mode. Press "▲" or "▼" in the main interface to increase/decrease the temperature in the chosen mode.

















#### 3) Clock setting

Long press "mode" for 3s to enter function interface. "⌚" clock icon will flicker. Press "Enter" to enter clock setting function. "⌚" icon will be constantly light and the first 2 digits on nixie tube will flicker. Press "▲" or "▼" to set minute. Press "⌚" when finish setting and "Enter" will be extinguished.















#### 4) Timing setting

##### a. Timing on setting





① Long press "mode" for 3s to enter function interface. "⌚" clock icon will flicker. Press "mode" again to enter timing on function. "⌚" will flicker and press "Enter" to enter timing on setting.

- ② At this moment, last 2 digits of the nixie tube display “01” which means the first group setting begins. Press “” to the next step.
- ③ By this time, mode icon will flicker and press “” to choose timing on mode. Press “” to confirm your choice and go to the next step.
- ④ By this time, the last 2 digits of the nixie tube will flicker and press “” or “” to adjust temperature and set the temperature of the inlet water. Press “” to confirm and move to the next step.
- ⑤ By this time, the first 2 digits of the nixie tube will flicker and press “” or “” to adjust time of timing on. Press “” to confirm and switch to minute setting automatically. The last 2 digits of the nixie tube will flicker and press “” or “” to adjust minute setting of timing on.(minimal unit of minute adjustment: 15 minutes) .
- ⑥ Press “” to confirm. The first group setting is finished and “” will be constantly light. When processing the second timing setting, repeat the 1-2 operation above. When the nixie tube displays “01” and flicker, press “” or “” to choose the timing on group. When the nixie tube displays “02” which means setting timing on function of the second group. Refers the timing on setting operation of group 1 to set that of group 2. Long press “” for 3s to return to the previous interface to reset the parameter during setting clock timing.

#### b. Timing off setting

- ① Long press “” for 3s in the main interface to enter function interface. Press “” circularly to enter timing off function. “” will flicker and press “” to enter timing off setting.
- ② At this moment, the last 2 digits of the nixie tube display “01” which means the first group setting begins. Press “” to the next step.
- ③ By this time, the first 2 digits of the nixie tube will flicker and press “” or “” to adjust time of timing off. Press “” to confirm and switch to minute setting automatically. The last 2 digits of the nixie tube will flicker and press “” or “” to adjust minute setting of timing off. Press “” to confirm. The first group setting is finished and “” will be constantly light.
- ④ When processing timing setting of group 2, repeat the 1-2 operation above. When the nixie tube displays “01” and flicker, press “” or “” to choose the timing off group. When the nixie tube displays “02” which means setting timing off function of the second group. Refers the timing off setting operation of group 1 to set that of group 2.



#### c. Cancel all timing on/off settings



Long press “” for 3s to enter function interface. “” clock icon will flicker and press “” to choose the timing function. “” and “” flicker simultaneously means choosing to cancel all timing functions.

Press “” to cancel timing settings. “” and “” both will be extinguished.







### 18.1.2 Functions of combination key

#### Force cooling function

Press “” and “” simultaneously for 3s in the main interface to enter into force cooling mode. The force cooling mode icon will be constantly light.

Press “” button and “” button simultaneously for 3s to quit force cooling mode. The unit will enter power off mode automatically when quitting force cooling mode.

#### Parameter query function

Press “  ” and “  ” simultaneously for 3s to enter into the interface of parameter query function. At this moment, first 2 digits of the nixie tube “ 88:88 ” will display sequence number and the last 2 digits is specific parameters. Press “  ” or “  ” to query the relative parameters. When enter the parameter query, it will quit automatically and return to the main interface. Press “  ” and “  ” simultaneously to quit parameter query manually.

### Checking content table (for control panel and wired controller check)

Order	Contents
01	Frequency
02	Running mode: 0-Power off, 1-water pump, 2-cooling, 3-heating, 4-force cooling
03	Fan speed: 0-Shutdown,1~7-Fan speed.
04	Total capacity requirements. Capacity before revised(Force cooling displays 5)
05	The revised capacity requirements. (Force cooling displays 5)
06	Cooling/heating temp. setting.
07	T3 temperature value (Outlet temperature of outdoor heat exchanger)
08	T4 temperature value (Outdoor environment temperature)
09	Tp temperature Value (Discharge refrigerant temperature)
10	Tin temp. Value (Inlet water temperature)
11	Tout temp. Value (Outlet water temperature)
12	Tb1 temp. Value (Temperature 1 of heat plate)
13	Tb2 temp. Value (Temperature 2 of heat plate)
14	T6 temp. Value (Reserved , Cooling fin surface temperature)
15	Outdoor unit operation current
16	Power supply voltage AD value
17	Electronic expansion valve opening steps(Step number *8)
18	The last error cord
19	The second error cord
20	The first error cord

#### 18.1.3 Auto-lock (unlock) function

If don't operate the controller in 60s, the keyboard will lock automatically. Press “mode” and “Enter” simultaneously for 3s to unlock.

#### 18.1.4 Factory Reset

In main interface, long press “Enter” for 3s, the unit will close and recovers to factory default mode. Display panel will display “OFF”.

## 18.2 Optional wired controller (KJR-120F/BMK-E, KJR-120F1/BMK-E)

### Features

Touch key operation; LCD displays operation parameters; Multiple timers; Real-time clock (battery life: 5~8 years).

#### 18.2.1 Overview

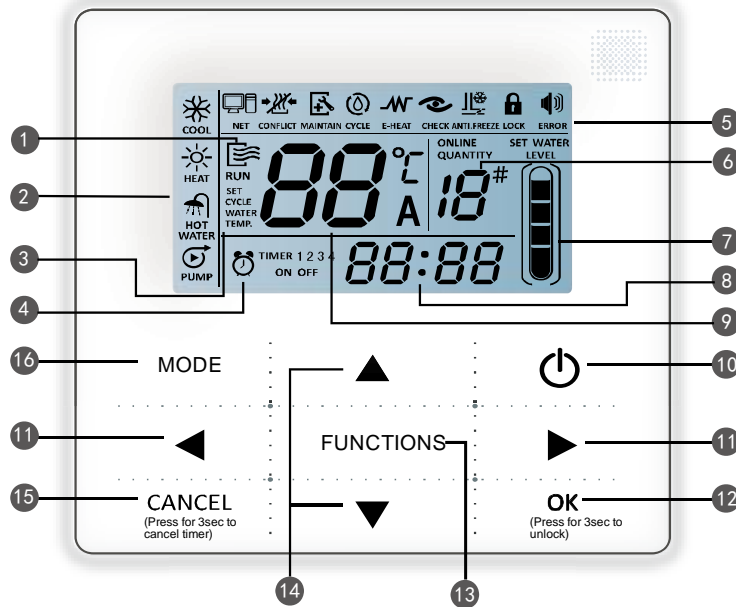

①.Operation icon	⑨).Water temp.
②).Code area	⑩).ON/OFF Key
③).Setting temperature	⑪).Left Right Key
④).Timing On/Off	⑫).Confirm Key
⑤).Function Icon	⑬).Function key
⑥).Unit number	⑭).Add and Reduce key
⑦).Water Level Indication (reserved)	⑮).Cancel key
⑧).Clock	⑯).Mode key

1. Operation icon : Indicate unit ON and OFF status; the icon displays when the unit is on and does not display when the unit is off;

2. Mode area: Indicate the main unit operating mode; details refer to its' manual;

3. Setting temperature: 2 status can be displayed: 

WATER TEMP.	SET WATER TEMP.
-------------	-----------------

 ;

4. Timing ON/OFF indication  : Indicate the timing information; details refers to page 10 of the manual;

5. Function icon





1)  : Displays when the unit controlled by remote switch;

2)  : The conflict icon.

3)  : Displays when the unit is needed. Press and hold “MODE” key for 3 seconds to cancel the icon and timing will restart until next maintenance;

4)  : The reserved icon. ;

5)  : The reserved icon. ;

- 6)  : Displays when check function is on; details refers to the manual;
- 7)  : Displays when ambient temperature is low which means the main unit need anti-freezing action;
- 8)  : Displays when no key operation for 2 minutes and all keys are locked. Press and hold “OK” key for 3 seconds to unlock;
- 9)  : Displays when error or protection occurs and means the unit need maintenance by professionals.

6The unit number: The user can set the number; details refer to page 16 of the manual;

7. Water level indication: The reserved icon;

8. Clock: Under normal status displays clock; Under timing setting displays the setting timing, details refer to page 15 of the manual;

9. Water temperature: Under normal status display water temperature; Under water temperature setting status displays the setting value; Under check status displays check parameter, details refer to Page 9, 18 of the manual;

10. ON/OFF key: Turn on and turn off functions, details refer to page 7 of the manual.

11. Right and Left key: Press these keys to check setting water temperature; Press right key to shift to the next step setting under timing setting status; Press these keys to turn over the unit parameter information under check status;

12. OK key: Press this key to confirm settings. Press and hold this key for 3 seconds to unlock under locking status;

13. Function key: Setting water temperature, timing and clock etc., details refer to Page 9-17; Press and hold this key for 3 seconds to enter check status, details refer to page 18 of the manual;

14. Add and Reduce key: Move up or move down values of temperature, timing etc;



15. Cancel key: Press this key to cancel parameter setting under setting status; Press and hold this key for 3 seconds to cancel timing when timing is valid;



16. Mode key: Power on the cooling function, heating function or water pump function, details refer to Page 8 of the manual.

## 18.2.2 Operation instructions

### a. Turn On and Turn Off the main unit

1) Press the On/Off key to control On and Off status of the main unit.

2) Under Off status, press the On/Off key “” to run the main unit, at that time the LCD of wired controller will display the operation icon “”. The main unit will running as the current setting of the wired controller.

3) Under On status, press the On/Off key “” to turn off the main unit and the operation icon “” on the LCD will disappear.

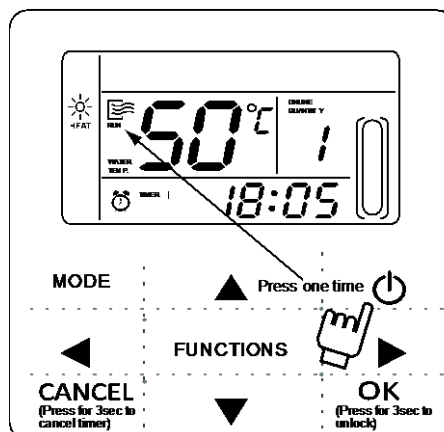

**b. Setting operating mode and function parameters**

1) Setting operating mode and water temperature

Setting operating mode: Press “MODE” key to choose operation mode. The setting mode will change as the following order each time the key is pressed:

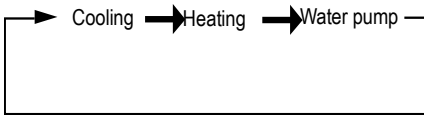

Press “OK” key or wait for 7 seconds to confirm. During the setting process, pressing the “CANCEL” key to exit without saving.

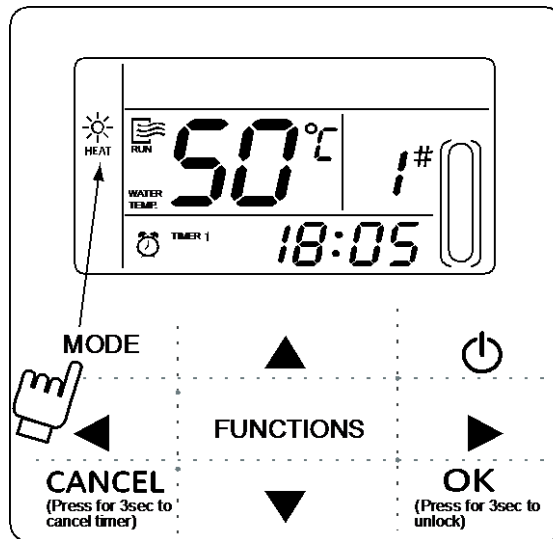

2) Setting water temperature:

Method 1: Press the “▲” or “▼” to adjust the water temperature after the controller is powered on. Press “OK” key or wait for 7 seconds to confirm.

Method 2: Setting water temperature in parameters function. Press “FUNCTIONS” key under main interface once to enter water temperature setting interface. Press the “▲” or “▼” to adjust the water temperature. Press “OK” key or wait for 7 seconds to confirm.

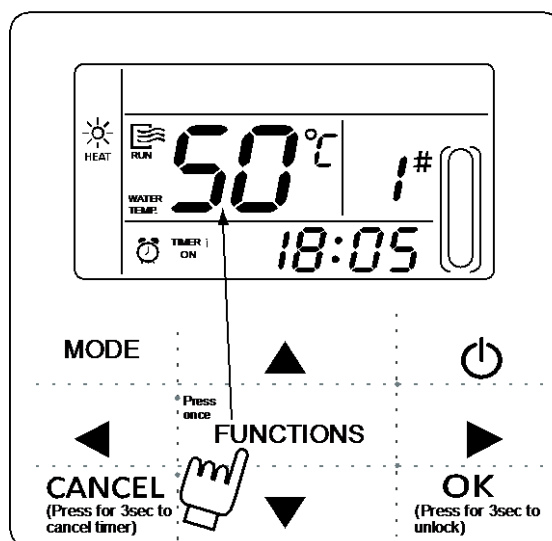

Water temperature setting check: To check the water temperature setting value, press the “◀” or “▶” key under the main page (the page displayed after the controller is powered on).

### c. Setting function parameters

Press “FUNCTIONS” key to choose operation parameters. The setting function parameters will change as the following order each time the key is pressed:

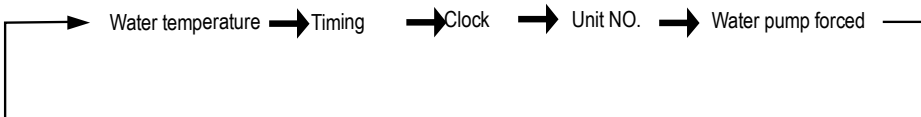

- 1) Timing setting: 3 timing periods can be set on the wired controller: Timer 1, Timer 2, Timer 3. These 3 timers can control the main unit to be turned ON and OFF 3 times at most during a day.
- 2) Setting method: press “FUNCTIONS” key under main page twice to enter timing setting. Then the LCD will display as the following:

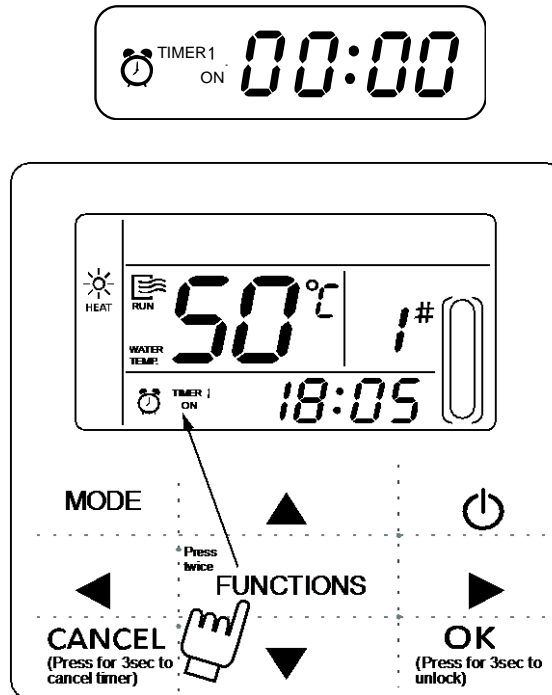

At this time the hour of the clock will flash, which means the current setting is the hour of Timer 1 “On” , press the “▲” or “▼” to adjust, press “▶” key when finished, and then the minute of the clock will flash, which means the current setting is the minute of Timer 1 “On”, press the “▲” or “▼” to adjust, press “▶” key when finished, the LCD will display as the following:

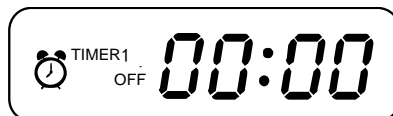

At this time the hour of the clock will flash, which means the current setting is the hour of Timer 1 “Off” , press the “▲” or “▼” to adjust, press “▶” key when finished, and then the minute of the clock will flash, which means the current setting is the minute of Timing 1 “Off”, press the “▲” or “▼” to adjust, press “▶” key when finished, the LCD will display as the following:

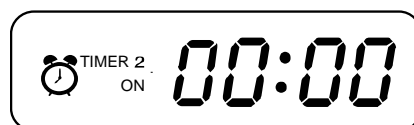

At this time the hour of the clock will flash, it means the current setting is the hour of the Timer 2 “On”. And the follow setting method will be the same as the Timer 1. Similarly, the setting of Timing 3 is the same as this method. After setting is finished, press “OK” key or wait for 7 seconds to confirm the setting,





and the LCD will display the effective timing information, as the following display:

Example of Timing setting

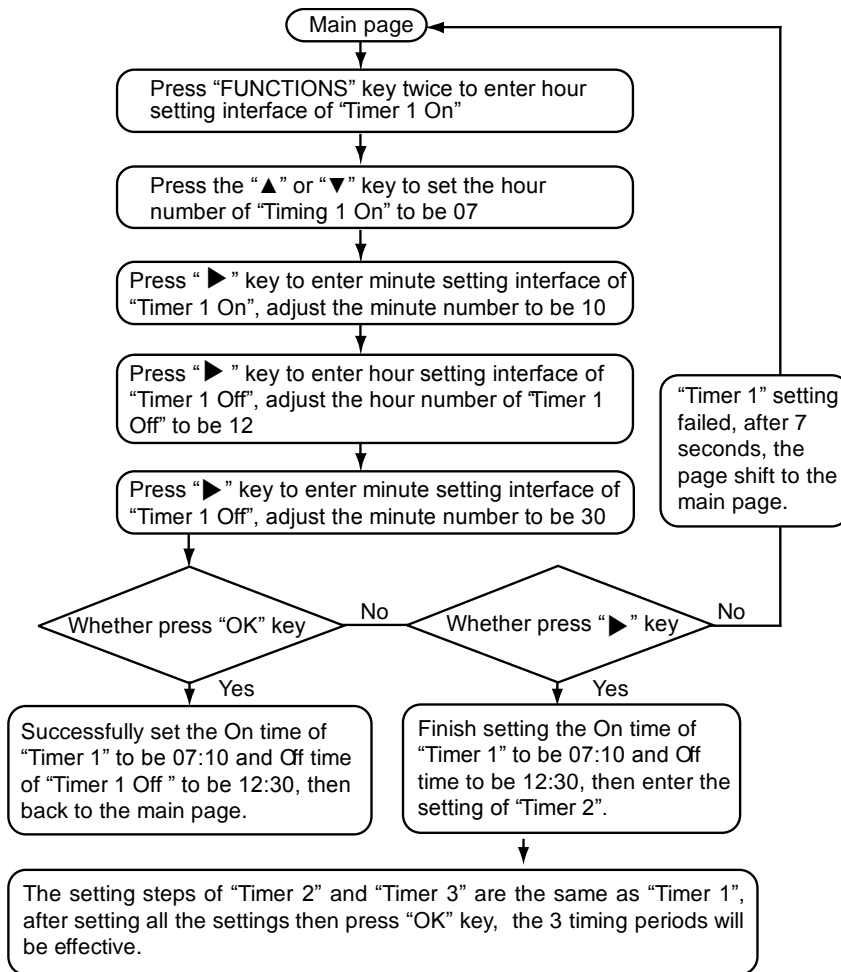

During any period of timing setting to press "OK" key , the timing periods which have been set will be effective (only if the "On" and "Off" of one timing period have been set, the setting is effective).

Check timing information: to check the timing which has been set, press "◀" or "▶" key under main page, the "On" and "Off" time of Timer1, Timer 2 and Timer3 will be displayed in turns.

Cancel timing: press and hold "CANCEL" key for 3 seconds, then all the effective timing periods will be cancelled.

Note: Correct: To avoid timing error, each period of timing should not be crossed. E.g.:

Correct:

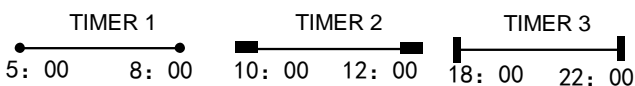

Wrong:

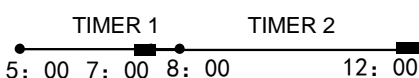

#### d. Setting clock

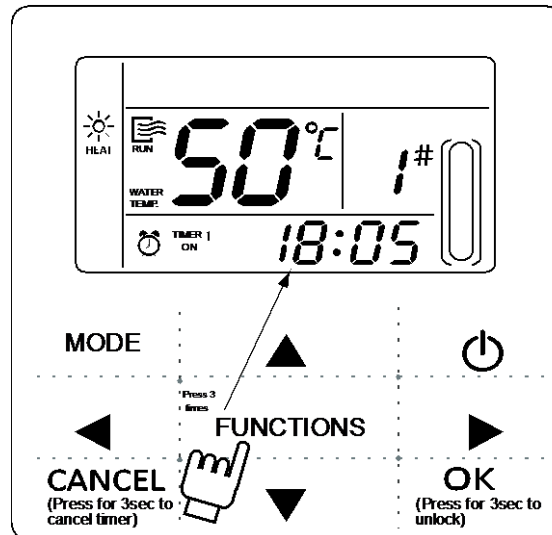

Press the “FUNCTION” key 3 times to enter clock setting. The hour of the clock will flash, which means the current setting is the hour of the clock, press the “▲” or “▼” to adjust, press “▶” key when finished, and then the minute of the clock will flash, it means the current setting is the minute of the clock, press the “▲” or “▼” to adjust, press “OK” key when finished or wait for 7 seconds to confirm. During the setting process pressing the “CANCEL” key to exit without saving.

NOTE: To get the correct timing On and timing Off time, please correctly set the clock!

#### e. Setting unit number

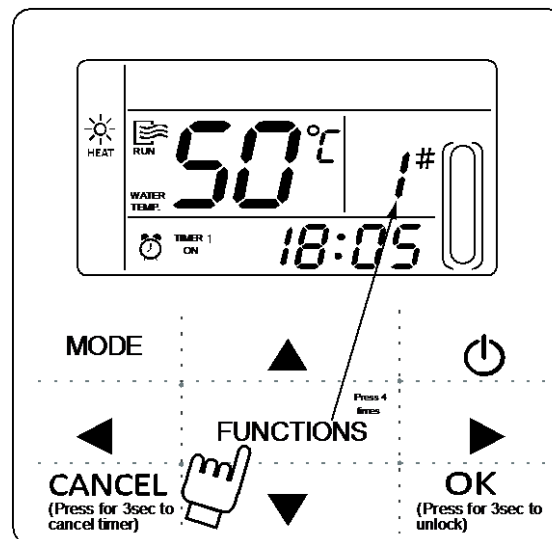

Press the “FUNCTIONS” key 4 times to enter the unit number setting. Press “▲” or “▼” to adjust the unit number. press “OK” key when finished or wait for 7 seconds to confirm. During the setting process pressing the “CANCEL” key to exit without saving. The setting value is 0-18.

**f. Force opening water pump**

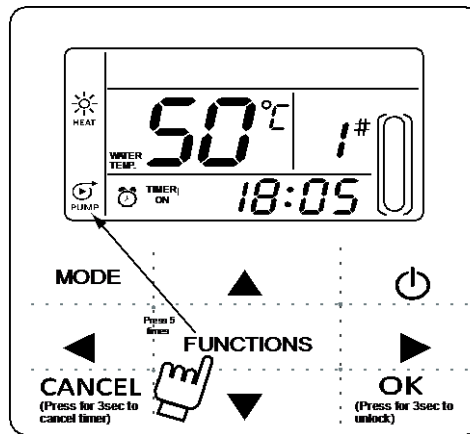

Press the “FUNCTIONS” key 5 times to force open the water pump. The water pump icon will flash. Press “OK” key to confirm. During the setting process, pressing the “CANCEL” key to exit without saving.

Note:

- a. Forcing water pump function is only limited to stand-by mode, others modes not response.
- b. Under forcing water pump function, other settings will not responsible, except stopping
- c. When communication disconnects, it will show E2 error in 2 minutes, the wired controller will automatically cancel the forcing water pump function; while connected, the wired controller keeps synchronizing with the unit( If forcing water pump function is still on-going, the controller keeping showing its status).
- d. The outdoor unit does not response after activating the forcing water pump function, (eg: forcing water pump function cannot be activated under forcing heating in stand-by mode),the function will be automatically stopped if it is not activated within 5 minutes.

**18.2.3 Checking function**

- 1) Check function allows the user to check all the operating parameters, error and protection information of the unit.
- 2) Entering method: press and hold “FUNCTIONS” key for 3 seconds to enter check interface, as the figure display:

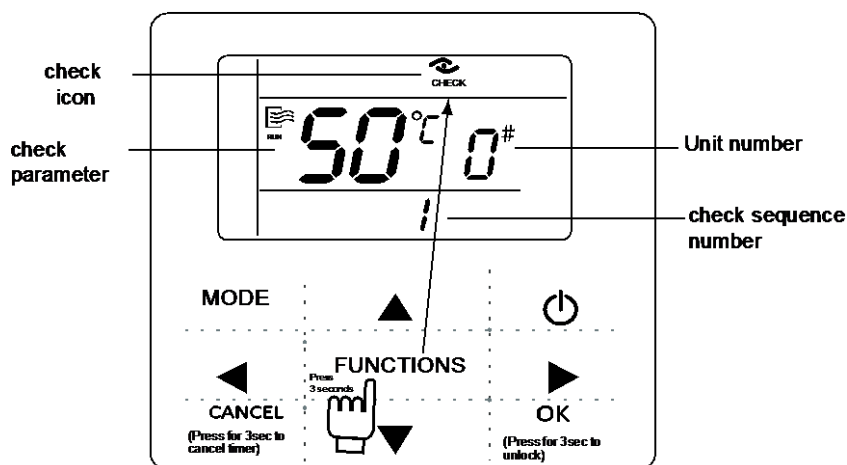

- 3) Press “◀” or “▶” to check all the status information of the unit. Check content when wired controller setting is 1. The checking content is the same as the control panel checking (Check list in page 60).

## 19. Troubleshooting

### 19.1 PCB parts instructions

MGC-V5W/D2N1, MGC-V7W/D2N1

PFC&IPM panel

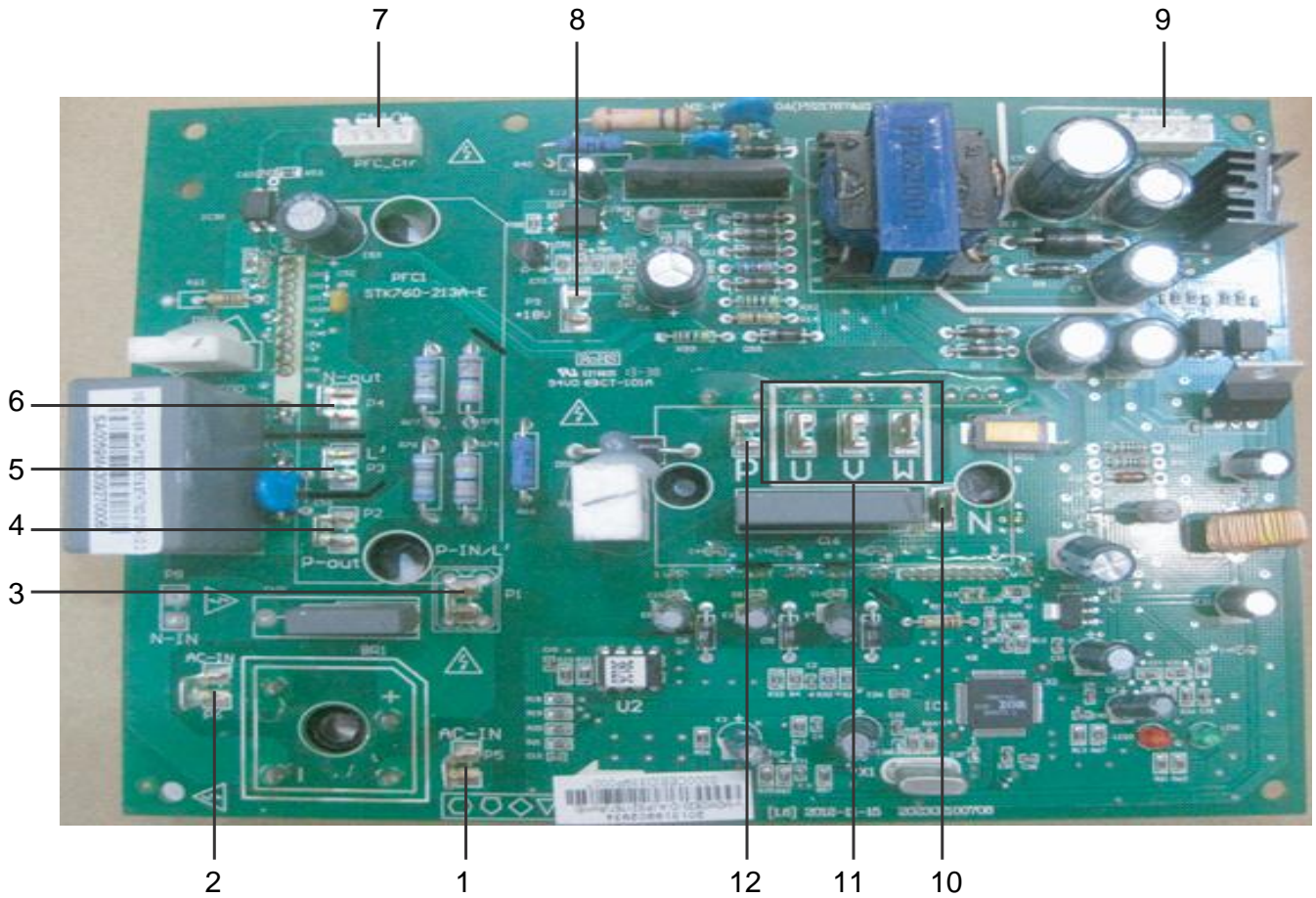

- 1. Input rectifier bridge port 1
- 2. Input rectifier bridge port 2
- 3. PFC inductance port 1
- 4. P-OUT
- 5. PFC inductance port 2
- 6. N-OUT

- 7. PFC control port
- 8. +18V port
- 9. IPDU communication port
- 10. IPM power port N
- 11. Compressor connection port U/V/W
- 12. IPM power port P

**Main control panel**

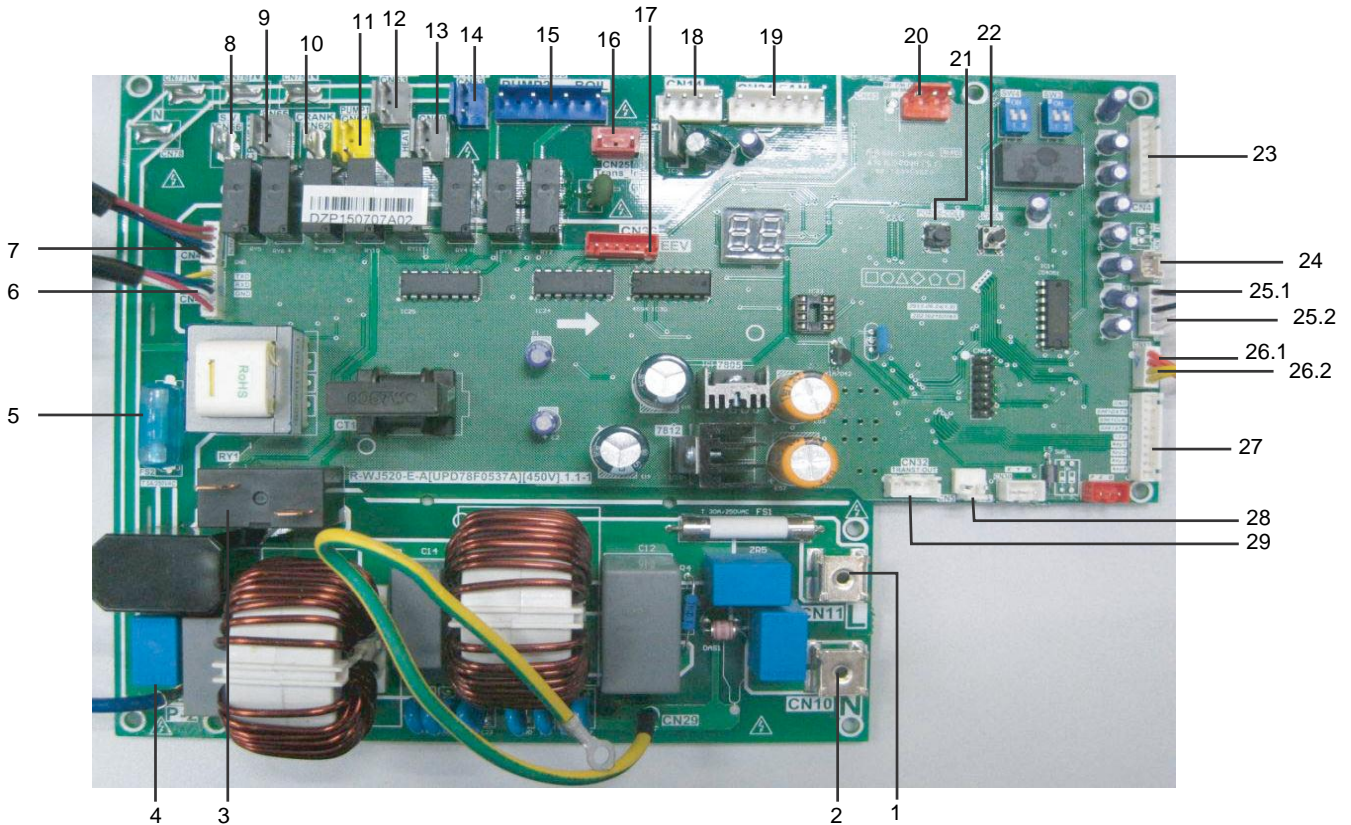

- |   |   |
|---|---|
| <ul style="list-style-type: none"> <li>1. Power L</li> <li>2. Power N</li> <li>3. Preliminary charging relay (rectifier bridge input port 1)</li> <li>4. Input rectifier bridge line (rectifier bridge input port 2)</li> <li>5. 5A fuse</li> <li>6. To IPDU</li> <li>7. To PFC</li> <li>8. Solenoid valve (Reserve)</li> <li>9. Electric heater of plate heat exchanger</li> <li>10. Electric heater of compressor</li> <li>11. Pump</li> <li>12. Electric heater of exhaust valve</li> <li>13. Electric heater of water flow switch</li> <li>14. 4-way valve</li> <li>15. Additional pump/Boil (Reserve)</li> </ul> | <ul style="list-style-type: none"> <li>16. Transformer input</li> <li>17. Electronic expansion valve</li> <li>18. DC fan power supply port</li> <li>19. DC fan port</li> <li>20. Remote control</li> <li>21. Force cooling switch</li> <li>22. Parameter checking switch</li> <li>23. Tin/Tout/Tb1 temperature sensor</li> <li>24. Discharge temperature sensor (Tp)</li> <li>25.1 Outlet of outdoor heat exchanger temperature sensor (T3)</li> <li>25.2 Ambient temperature sensor(T4)</li> <li>26.1 Low pressure switch</li> <li>26.2 High pressure switch</li> <li>27. Operation and display panel port</li> <li>28. Water flow switch</li> <li>29. Transformer output</li> </ul> |
|---|---|

**DC filter panel**

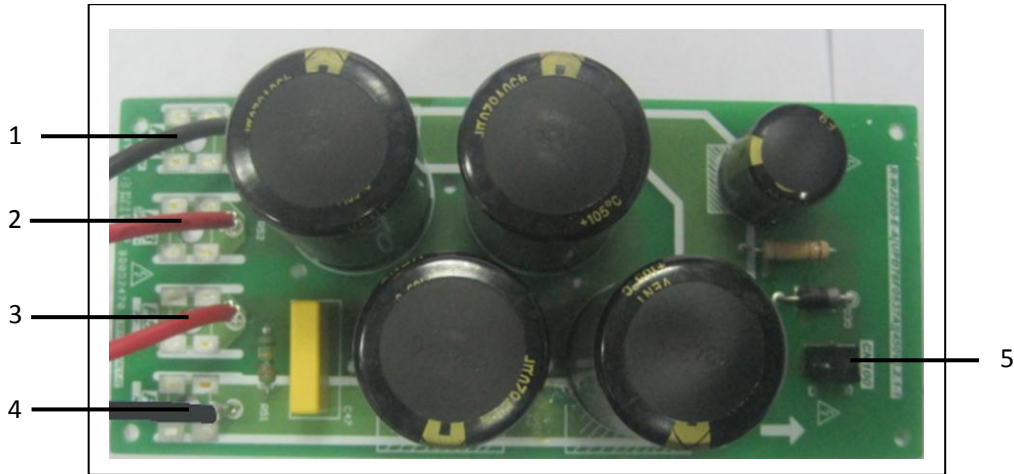

- 1. IPM Power supply N
- 2. IPM Power supply P
- 3. PFC output power P

- 4. PFC output power N
- 5. DC 380V (DC fan power supply port)

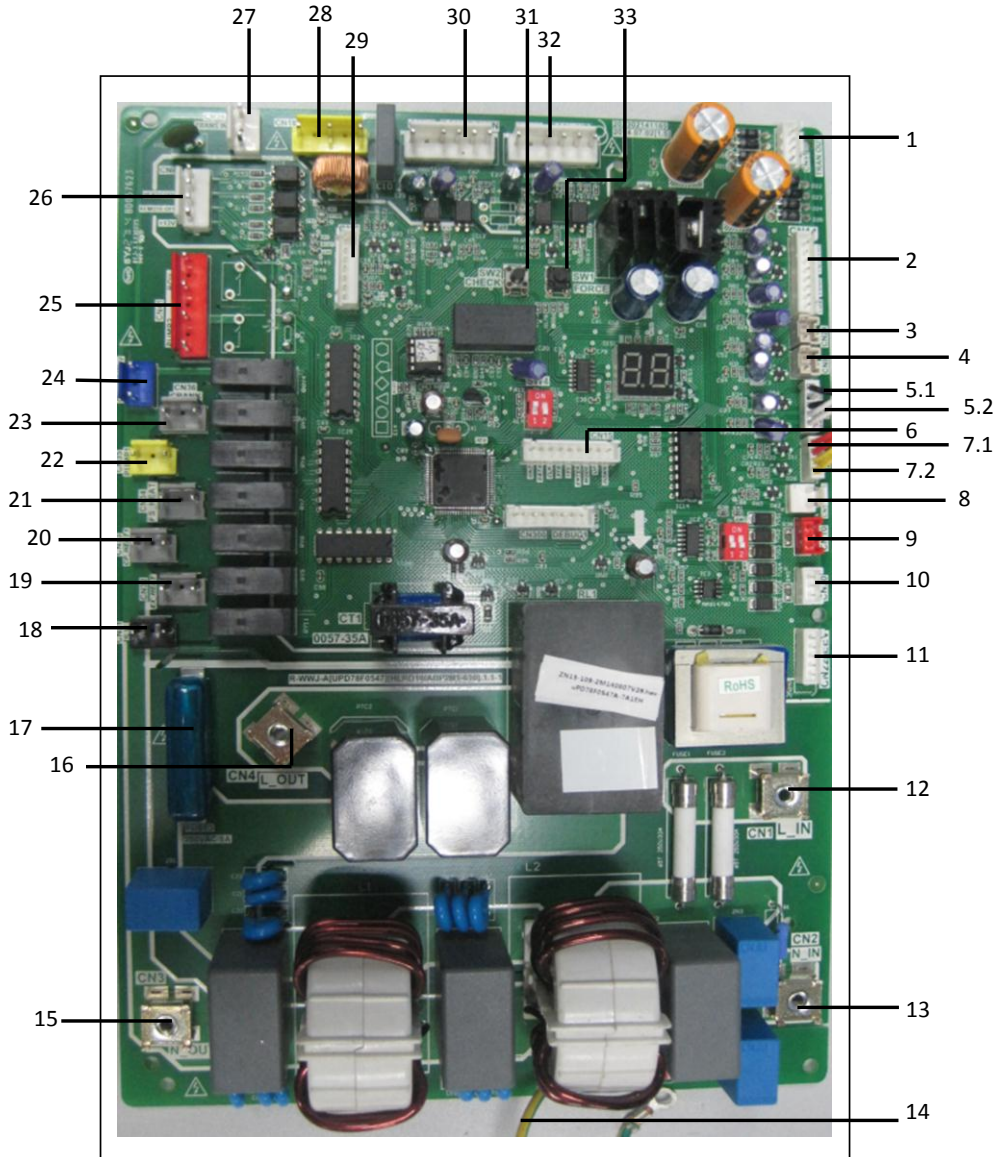
**MGC-V10W/D2N1, MGC-V12W/D2N1****Main control panel**

- |   |  |
|---|--|
| 1. Transformer output port  | 16. Rectifier bridge input port L                    |
| 2. Tin/Tb1/Tout/Tb2 temperature sensor port<br>Note: Tin: water inlet temp. Tout: water outlet temp.<br>Tb1: Temp. 1 of plate heat exchanger<br>Tb2: Temp.2 of plate heat exchanger | 17. 8A fuse tube                                     |
| 3. Radiator temperature sensor port(Reserved) (T6)  | 18. Solenoid valve port (Reserved)                   |
| 4. Discharge temperature sensor port  | 19. Exhaust valve electric heater port               |
| 5.1 Outlet of outdoor heat exchanger temp. sensor port(T3)  | 21. Plate heat exchanger electric heater             |
| 5.2 Ambient temp. sensor port (T4)  | 22. Differential pressure valve electric heater port |
| 6. Operation and display panel port   | 23. Built-in water pump port                         |
| 7.1 Low pressure switch   | 24. Compressor electric heater                       |
| 7.2 High pressure switch  | 25. 4-way valve port                                 |
| 8. Differential pressure valve port   | 26. External pump/Remote alarm port                  |
| 9. Factory debug port   | 27. Transformer input port                           |
| 10. Wired controller port   | 28. P/N/+15V port                                    |
| 11. Electric expansion valve port   | 29. Communication port between IPDU and main PCB     |
| 12. Power supply input port L   | 30. Down DC fan port                                 |
| 13. Power supply input port N   | 31. Check touch switch                               |
| 14. Ground wire   | 32. Up DC fan port                                   |
| 15. Rectifier bridge input port N   | 33. Force-cooling touch switch                       |

**PFC Module**

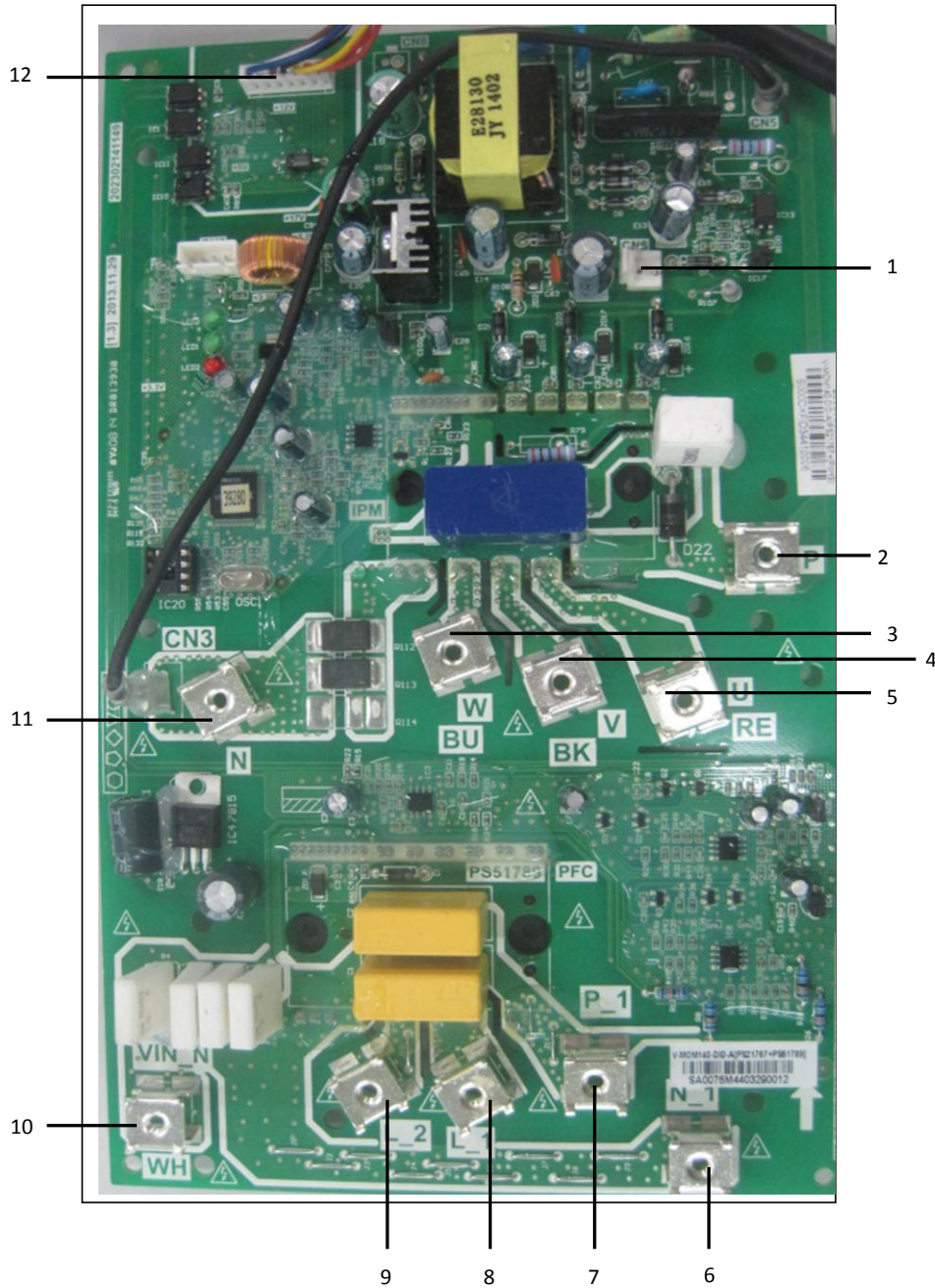

- |  |  |
|--|--|
| 1. +18V output port                      | 7. PFC output P                              |
| 2. Input Port P for IPM                  | 8. PFC inductance port L_1                   |
| 3. Power supply port U of the compressor | 9. PFC inductance port L_2                   |
| 4. Power supply port V of the compressor | 10. PFC input N                              |
| 5. Power supply port W of the compressor | 11. IPM input N                              |
| 6. PFC output N                          | 12. Communication port to main control board |





- 19. Electric heater port of Plate heat exchanger
- 20. Electric heater port of differential pressure valve
- 21. Built-in water pump port
- 22. Electric heater of the compressor
- 23. Precharge AC contactor port
- 24. 4-way valve port
- 25. External water pump/Remote alarm port
- 26. Up DC fan port
- 27. Down DC fan port
- 28. Power supply port for switching power supply of PFC board
- 29. Drive module port
- 30. P/N/+15V port

**IPM module**

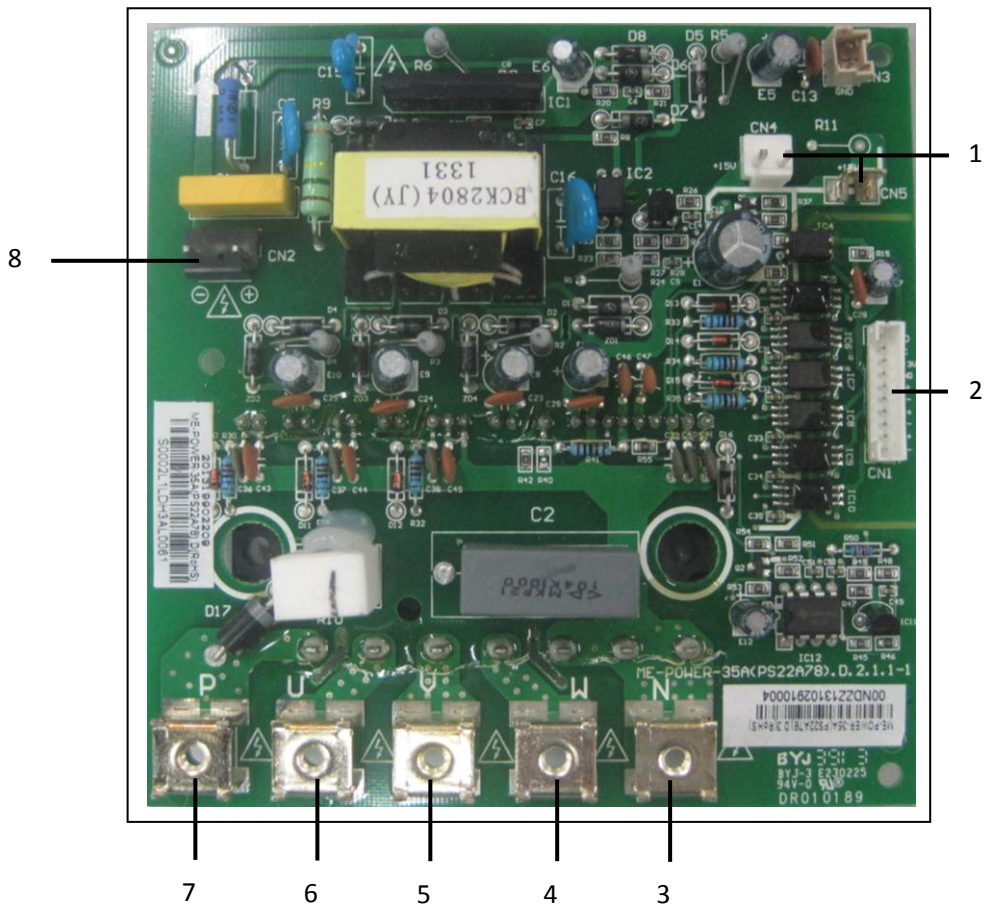

- 1. +15V output port
- 2. communication port to main control board
- 3. IPM input port N
- 4. Compressor connection port W
- 5. Compressor connection port V
- 6. Compressor connection port U
- 7. IPM input P
- 8. Power supply port for switching power supply

**Filter board**

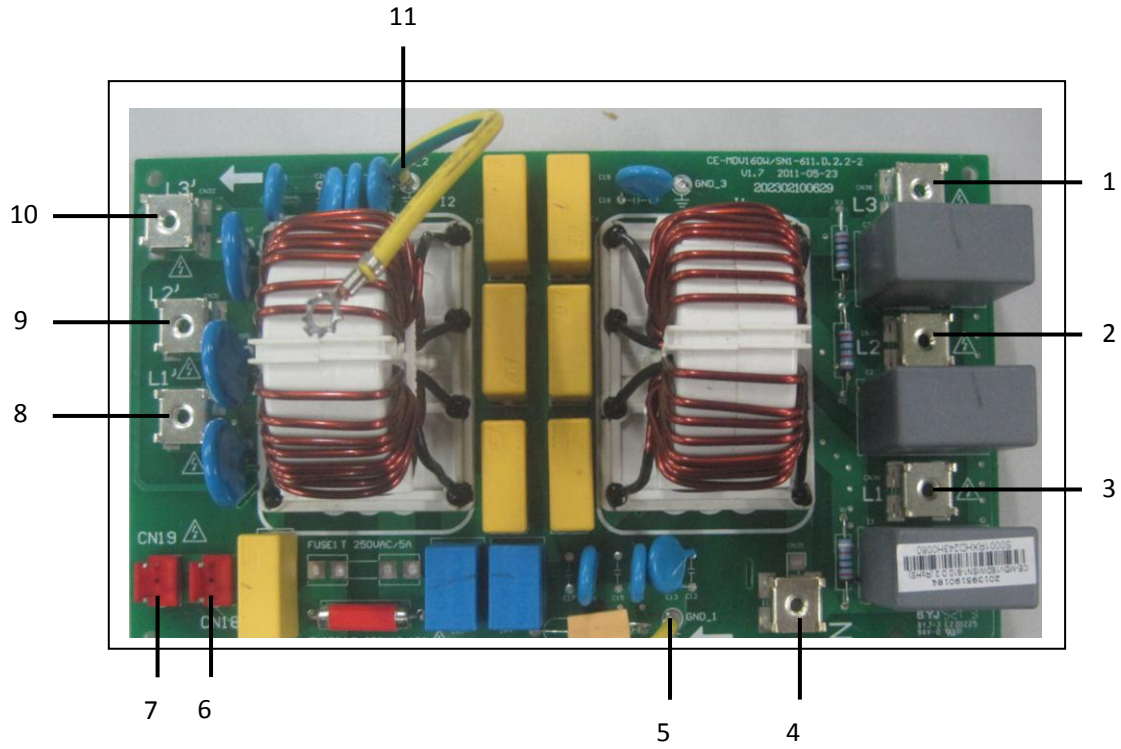

- |   |  |
|---|--|
| 1. Power supply port L3                     | 2. Power supply port L2                            |
| 3. Power input port L1                      | 4. Power input port N                              |
| 5. Ground wire                              | 6. Loaded power supply port for main control board |
| 7. Power supply port for main control board | 8. Power output port L1 after filtering            |
| 9. Power output port L2 after filtering     | 10. Power output port L3 after filtering           |
| 11. Ground wire                             |  |

### 19.2 Function setting dial switches instructions

For 5/7kW

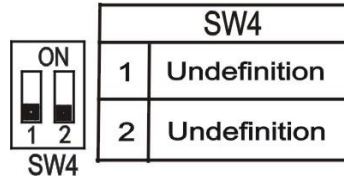
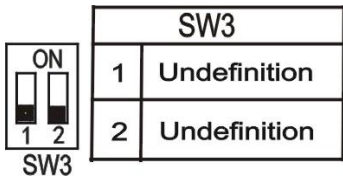

For 10kW

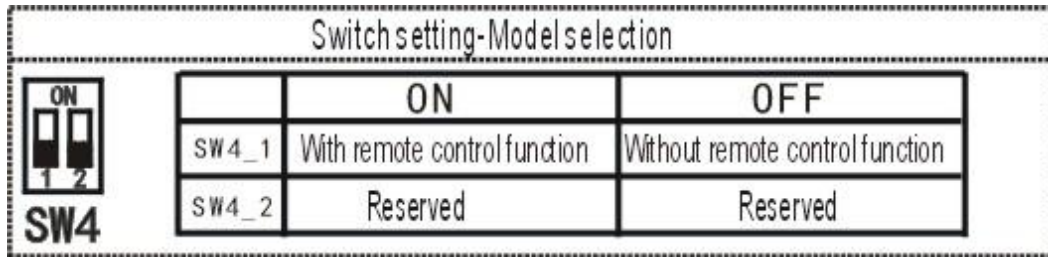

For 12-16kW

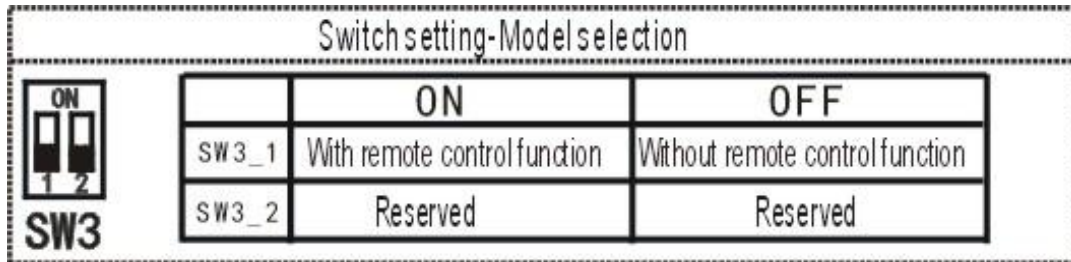

### 19.3. Query function for PCB checking switch

Press checking touch switch on PCB to check the parameters. The check list on PCB is in table below.

**Query content table on PCB**

No.	Content	Note
0	Normal display	Clock displays when standby. Inlet water temperature displays when running. dF displays when defrosting. Pb displays when anti-freeze running. d0 displays when oil return, d8 displays when remote control is off.
1	Frequency	Display operating frequency when the unit is in cooling mode and heating mode.
2	Operating mode	0-Power off,1-water pump,2-cooling,3-heating,4-force cooling
3	Operating fan speed level	0-Power off (1-7)
4	The total required capacity before revised	Actual value (Force cooling displays 5)
5	Capacity requirements after revised	Actual value (Force cooling displays 5)
6	Temperature set	Actual setting temperature under cooling or heating mode
7	T3	Actual value(Outlet temperature of outdoor heat exchanger)
8	T4	Actual value(Outdoor ambient temperature)
9	Tp	Actual value(Compressor discharged temperature)
10	Tin	Actual value(Water inlet temperature of plate heat exchanger)
11	Tout	Actual value(Water outlet temperature of plate heat exchangers)
12	Tb1	Plate heat exchanger anti-freezing temperature sensor 1
13	Tb2	Plate heat exchanger anti-freezing temperature sensor 2
14	T6	Reserved (Cooling fin surface temperature(reserved))
15	Operation current	Actual value
16	Power supply voltage	Actual AD value
17	EXV Opening degrees	Step number×8
18	Model	5kW:5; 7kW:7; 10kW:10; 12kW:12; 14kW:14;16kW:16 (Operation panel has no such function)
19	Version number	----(Operation panel has no such function)
20	Err 1	The last one malfunction code

## 19.4 Error code table





### 5/7kW

Error Code	Content	Note
E9	EEPROM malfunction	The same as 10-16kW
H0	Communication malfunctions between main chip and IPDU.	
E4	T3,T4 sensor malfunction	
E5	Voltage protection malfunction	
E6	DC fan motor malfunction	
EA	A fan in the A region run for more than 5 minutes in heating mode	
Eb	There are two times E6 fault in 10 minutes (recovery after power off)	
HH	Inlet water temperature sensor malfunctions for 5/7kW models.	5/7kW
EC	Outlet water temperature sensor malfunction (5/7kW)	
C0	Temperature sensor malfunction of plate heat exchanger for 5/7kW.	The same as 10-16kW
P1	High pressure protection	
P2	Low pressure protection	
P3	Current protection of the compressor	
P4	Discharged temperature protection	
P5	T3 high temperature protection of outdoor condenser	
P6	IPDU module protection	
P8	Typhoon protection	5/7kW
CH	Protection when temperature difference between inlet & outlet water in heating mode is too large for 5/7kW	
CL	Protection when temperature difference between inlet & outlet water in cooling mode is too large for 5/7kW.	
CP	Anti-freeze protection of plate heat exchanger for 5/7kW	The same as 10-16kW
Pb	System anti-freeze protection	
C8	Water flow switch protection malfunction	5/7kW
PH	Protection when water temperature in heating mode is too high for 5/7kW.	
dF	Defrosting	The same as 10-16kW
d8	Remote control	

**10-16kW**

<b>Error Code</b>	<b>Content</b>	<b>Note</b>
E9	EEPROM malfunction	The same as 5/7kW
H0	Communication malfunctions between main chip and IPDU.	
E4	T3,T4 sensor malfunction	
E5	Voltage protection malfunction	
E6	DC fan motor malfunction	
EA	A fan in the A region run for more than 5 minutes in heating mode	
Eb	There are two times E6 fault in 10 minutes (recovery after power off)	
C0	Inlet water temperature sensor malfunction for 10~16kW models.	10-16kW
C1	Outlet water temperature sensor malfunction (10-16kW)	
F7	Sensor temperature 1 of plate heat exchangers for 10-16kW.	
F8	Sensor temperature 2 of plate heat exchangers for 10-16kW.	
PL	Reserved for 10-16kW.	The same as 5/7kW
P1	High pressure protection	
P2	Low pressure protection	
P3	Current protection of the compressor	
P4	Discharged temperature protection	
P5	T3 high temperature protection of outdoor condenser	
P6	IPDU module protection	
P8	Typhoon protection	10-16kW
CH	Protection when water temperature is too high in heating mode.	
CL	To low water temperature protection in heating mode for 10-16kW	
CP	Anti-idling protection for water pump	The same as 5/7kW
Pb	System anti-freeze protection	
C8	Water flow switch protection malfunction	10-16kW
PH	Protection when temperature difference between inlet water & outlet water is too large for 10-16kW.	
dF	Defrosting	The same as 5/7kW
d8	Remote control	

## 20. Accessories

Item	Name of accessory	Qty.	Shape
1	Installation and operation manual	1	
2	Rubber sealed ring	2	
3	Outlet connection pipe	1	
4	Straight screwdriver	1	

## 21. Optional Accessories

No.	Name	Specification	Remark
1	Wired controller	KJR-120F/BMK-E (with Midea logo)	Customized
2	Wired controller	KJR-120F1/BMK-E (without Midea logo)	Customized



## 22. Appendix

Temperature-Resistance characteristic sheet for pipe temperature sensor, ambient temperature sensor, inlet water temperature sensor and outlet water temperature sensor.

Sensor characteristic sheet Unit: Temp:°C--K, Ratio:KΩ

Temp.	Ratio	Temp.	Ratio	Temp.	Ratio	Temp.	Ratio
-20	115.266	20	12.6431	60	2.35774	100	0.62973
-19	108.146	21	12.0561	61	2.27249	101	0.61148
-18	101.517	22	11.5	62	2.19073	102	0.59386
-17	96.3423	23	10.9731	63	2.11241	103	0.57683
-16	89.5865	24	10.4736	64	2.03732	104	0.56038
-15	84.219	25	10	65	1.96532	105	0.54448
-14	79.311	26	9.55074	66	1.89627	106	0.52912
-13	74.536	27	9.12445	67	1.83003	107	0.51426
-12	70.1698	28	8.71983	68	1.76647	108	0.49989
-11	66.0898	29	8.33566	69	1.70547	109	0.486
-10	62.2756	30	7.97078	70	1.64691	110	0.47256
-9	58.7079	31	7.62411	71	1.59068	111	0.45957
-8	56.3694	32	7.29464	72	1.53668	112	0.44699
-7	52.2438	33	6.98142	73	1.48481	113	0.43482
-6	49.3161	34	6.68355	74	1.43498	114	0.42304
-5	46.5725	35	6.40021	75	1.38703	115	0.41164
-4	44	36	6.13059	76	1.34105	116	0.4006
-3	41.5878	37	5.87359	77	1.29078	117	0.38991
-2	39.8239	38	5.62961	78	1.25423	118	0.37956
-1	37.1988	39	5.39689	79	1.2133	119	0.36954
0	35.2024	40	5.17519	80	1.17393	120	0.35982
1	33.3269	41	4.96392	81	1.13604	121	0.35042
2	31.5635	42	4.76253	82	1.09958	122	0.3413
3	29.9058	43	4.5705	83	1.06448	123	0.33246
4	28.3459	44	4.38736	84	1.03069	124	0.3239
5	26.8778	45	4.21263	85	0.99815	125	0.31559
6	25.4954	46	4.04589	86	0.96681	126	0.30754
7	24.1932	47	3.88673	87	0.93662	127	0.29974
8	22.5662	48	3.73476	88	0.90753	128	0.29216
9	21.8094	49	3.58962	89	0.8795	129	0.28482
10	20.7184	50	3.45097	90	0.85248	130	0.2777
11	19.6891	51	3.31847	91	0.82643	131	0.27078
12	18.7177	52	3.19183	92	0.80132	132	0.26408
13	17.8005	53	3.07075	93	0.77709	133	0.25757
14	16.9341	54	2.95896	94	0.75373	134	0.25125
15	16.1156	55	2.84421	95	0.73119	135	0.24512
16	15.3418	56	2.73823	96	0.70944	136	0.23916
17	14.6181	57	2.63682	97	0.68844	137	0.23338
18	13.918	58	2.53973	98	0.66818	138	0.22776
19	13.2631	59	2.44677	99	0.64862	139	0.22231